

2.0M IP MINI BULLET CAMERA

BFN-B602N
BFN-B602P



FEATURES

Real-time High Definition Bullet Camera

Using the state of art video compression engine, real time HD video streams of 1080p can be delivered for recording and monitoring.

Triple codec, Simultaneous Multi Streaming

Triple H/W codec enables to transmit max 3 independent streams with different settings for different requirements. Therefore, it is possible to combine seamless remote video monitoring using H.264 with simultaneous transmission of high quality MPEG-4 to Network Video Recorder. Also, additional MJPEG can be delivered for Mobile devices such as Smart Phone or PDA.

Local SD Card Backup

Some important sequence of still images can be stored in the SDHC memory card. This action can be configured to work with pre-post- alarm event or a given interval.

Day & Night by ICR

For increased sensitivity of image sensor efficiently, a mechanical actuator can shift infrared (IR) Cut filter to disengage from image path automatically in the low light environment.

POE

Built-in Power over Ethernet (IEEE 802.3af) makes installation easier, cheaper and more secure since Power over Ethernet can take advantage of UPS (uninterrupted power supply), which provides back-up power in case of a power failure.

Weather Proof Design

Due to IP66 environment protection as well as speed bullet camera will serve you all the time regardless of rain, snow and storm.



Dimension (unit : mm)

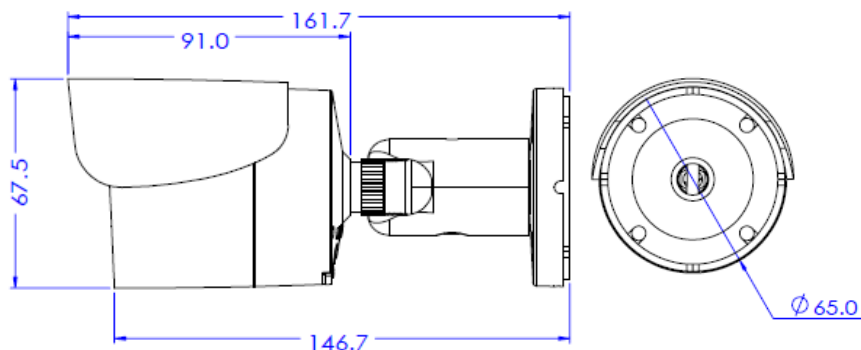

Specification

CAMERA	
Image Device	1/2.8" 2.0M Progressive Scan CMOS sensor
Effective Pixels	1920 (H) x 1080 (V)
Aspect Ratio	HD: 16:9
Focal Length	6.0mm, F2.0(Digital zoom : X12)
Horizontal angle	57°
MIN. Illumination	COLOR : 0.5Lux @ F2.5, 30IRE B/W : 0.00Lux @ IR LED ON
Day & Night	Auto / Day / Night(ICR)
Shutter Speed	1/30~1/60,000 sec
Focus	Manual
AGC	Max 41dB
White Balance	Auto, Manual, Indoor, Outdoor, Preset
IR LED	24 IR LED(50ft)
BLC / WDR	OFF / WDR/ BLC
DNR	OFF/ MID / HIGH
DSS	Max 8x
Other Functions	Image Flip, Mirror,

GENERAL	
Camera Posture	3 Axis (Pan/Tilt/Rotation)
Power	DC 12V Max. 500mA POE IEEE 802.3af
Approvals	FCC, CE, IP66, ROHS
Housing	Weather proof Color: Dark Gray or Black
Material	Aluminum Die-casting
Mounting Bracket	Wall mount bracket
Dimension	Net (W x H) 161.7 x 67.5
Weight	Net: 1.0 Kg,
Operating Temp.	-30°C ~ 50°C

NETWORK		
OS	Embedded Linux	
Video Compression	Triple Codec,H.264/MPEG4/MJPEG	
Video Streaming	Multi Streaming CBR/VBR (Controllable frame rate and Bandwidth)	
Resolution	H.264/MPEG4: 1080P/720P/D1/CIF MJPEG : QCIF	
Frame Rate	Max. 30 /25 fps for 1080p/720P/D1/CIF/QCIF	
Local Storage	SDHC memory card (card is not included)	
Motion detection	Notification: FTP, e-mail, Alarm out, JPEG Recording on SD	
Alarm	Pre-Post Alarm	
Max No. of Clients	5	
Protocols Support	IPv4	ONVIF, TCP/IP, UDP/IP, RTP(UDP/TCP), RTSP, NTP, HTTP,HTTPS, SSL, DNS, DDNS, DHCP, FTP, SMTP, ICMP, SNMPv1/v2c/v3(MIB-2)
	IPv6	TCP/IP, HTTP, HTTPS, DHCP
	DDNS	Proprietary: NET4C Public DDNS services Support: www.dyndns.com, www.no-ip.com
	Security	HTTPS(SSL), Digest Authentication(ID/PW)
OS Supported	Windows 7, Vista, XP , 2000	