

AXIS P13 Network Camera Series

Superb image quality for video surveillance in any environment.



- > Superb video quality including HDTV and 5 megapixel
- > Lightfinder technology
- > P-Iris control
- > Multiple H.264 video streams
- > Digital PTZ and multi-view streaming
- > Outdoor-ready models

AXIS P13 Network Camera Series comprises of indoor and outdoor-ready fixed cameras that deliver superb image quality with H.264 compression and are ideal for high-performance surveillance in any indoor or outdoor environment. The megapixel models also deliver HDTV 720p/1080p video.

AXIS P13 Series offers light sensitive models from SVGA up to 5 megapixel resolution, including HDTV 720p and 1080p video. Models are available in both indoor and outdoor-ready versions. The cameras provide wide dynamic range, and day and night functionality for superb image quality in daylight and dark conditions.

The SVGA and HDTV 720p models support Axis' Lightfinder technology, which makes these cameras extremely sensitive to low light. The HDTV 1080p and 5-megapixel cameras offer the unique and revolutionary P-Iris control, which allows the cameras to precisely control the iris position to optimize depth of field and lens resolution for optimal image sharpness.

All AXIS P13 cameras deliver multiple H.264 and Motion JPEG video streams.

All models have a remote back focus function that enables the focus to be fine-tuned from a computer. All models also offer digital pan/tilt/zoom, and the HDTV 1080p and 5-megapixel cameras additionally provide multi-view streaming. The cameras are equipped with a serial port for communication with auxiliary equipment such as pan/tilt head in order to remotely change the camera direction.

AXIS P13 cameras support Power over Ethernet (PoE) for easy installation. The outdoor-ready models operate using PoE and High PoE in temperatures from -40 °C to 50 °C (-40 °F to 122 °F).



High-performance indoor/outdoor cameras

AXIS P13 Series offers fixed network cameras suitable for a range of video surveillance applications, including government and industrial buildings, retail environments, airports, railway stations and schools.

Easy installation with focus assistant, remote focus and pixel counter

Setting the focus on all AXIS P13 cameras is made easy with the focus assistant, which indicates with a flashing green LED when an image is in focus after manually adjusting the lens. Additionally, the cameras offer remote back focus, which allows the focus to be fine-tuned from a computer. The pixel counter further helps the installer verify that the pixel resolution of an object fulfills regulatory or customer requirements, for example, for facial identification.

Digital PTZ and multi-view streaming

All camera models support digital pan/tilt/zoom, which allows a selected area of interest to be cropped from the full view for viewing or recording, thereby minimizing the bit rate and storage needs. The HDTV 1080p and 5-megapixel cameras also support multi-view streaming, which allows several cropped view areas to be streamed simultaneously, simulating up to eight virtual cameras.

Lightfinder technology

AXIS P1353/-E and P1354/-E Network Cameras incorporate Axis' unique Lightfinder technology. The outstanding light sensitivity, with maintained colors even in very poor lighting conditions, is obtained by a combination of Axis' expertise in image processing, system-on-chip development and selection of the best optical components.

For more on Lightfinder technology, go to:

www.axis.com/corporate/corp/tech_papers.htm

P-Iris control

AXIS P1355/-E and P1357/-E feature the advanced precise iris control that comprises a special P-Iris lens, together with dedicated software in the camera, to set the best iris position for optimal depth of field, resolution, image contrast and clarity. Good depth of field implies that objects at different distances from the camera are in focus simultaneously.

For more on P-Iris and iris control, go to:

www.axis.com/corporate/corp/tech_papers.htm

Outdoor-ready models

AXIS P13-E Network Cameras save installation time and costs since they are ready out of the box for mounting outdoors. The IP66-rated cameras have protection against dust, rain, snow and sunlight, and can operate in temperatures as low as -40 °C (-40 °F). The cameras are powered by Power over Ethernet,

which makes installation easy since there is no need for a separate power cable. An integrated dehumidifying membrane eliminates any humidity caught in the camera enclosure during installation. The cameras enable easy mounting of an infrared illuminator under the enclosure. They come with a wall mount bracket, sunshield and cable glands.



Technical Specifications – AXIS P13 Network Camera Series

Camera		Network	
Indoor models	AXIS P1353: SVGA, Lightfinder AXIS P1354: 1 MP/720p HDTV, Lightfinder AXIS P1355: 1080p HDTV AXIS P1357: 3 MP/5 MP	Security	Password protection, IP address filtering, HTTPS encryption**, IEEE 802.1X network access control**, digest authentication, user access log
Outdoor models	AXIS P1353-E: SVGA, Lightfinder AXIS P1354-E: 1 MP/720p HDTV, Lightfinder AXIS P1355-E: 1080p HDTV AXIS P1357-E: 3 MP/5 MP	Supported protocols	IPv4/v6, HTTP, HTTPS**, QoS Layer 3 DiffServ, FTP, CIFS/SMB, SMTP, Bonjour, UPnP™, SNMPv1/v2c/v3(MIB-II), DNS, DynDNS, NTP, RTSP, RTP, TCP, UDP, IGMP, RTCP, ICMP, DHCP, ARP, SOCKS
Image sensor	AXIS P1353/-E, P1354/-E: Progressive scan RGB CMOS 1/3" AXIS P1355/-E: Progressive scan RGB CMOS 1/2.8" AXIS P1357/-E: Progressive scan RGB CMOS 1/3.2"	System integration	Application Programming Interface Open API for software integration, including the ONVIF Profile S, specification available at www.onvif.org , as well as VAPIX® and AXIS Camera Application Platform from Axis Communications, specifications available at www.axis.com Support for AXIS Video Hosting System (AVHS) with One-Click Camera connection Support for AXIS Camera Companion
Lens	All AXIS P13 cameras use IR-corrected, CS-mount lens AXIS P1353/-E, P1354/-E: DC-iris AXIS P1353: Varifocal 3 – 8 mm: 82° – 34° view, F1.0 AXIS P1354: Varifocal 2.8 – 8 mm: 100° – 34° view, F1.2 AXIS P1353-E: Varifocal 3 – 8 mm: 80° – 34° view, F1.0 AXIS P1354-E: Varifocal 2.8 – 8 mm: 80° – 34° view, F1.2 AXIS P1355/-E, P1357/-E: P-Iris AXIS P1355: Varifocal 2.8 – 8 mm: 109° – 39° view, F1.2 AXIS P1355-E: Varifocal 2.8 – 8 mm: 80° – 39° view, F1.2 AXIS P1357: Varifocal 2.8 – 8 mm: 92° – 32° view, F1.2 AXIS P1357-E: Varifocal 2.8 – 8 mm: 80° – 32° view, F1.2 Note: All angles above are horizontal angle of view	Intelligent video	Video motion detection, active tampering alarm, audio detection Support for AXIS Camera Application Platform enabling installation of additional applications
Day and night	Automatically removable infrared-cut filter	Event triggers	Intelligent video, external input, audio level, time scheduled, edge storage events
Minimum illumination	AXIS P1353/-E: Color: 0.1 lux, F1.0, B/W: 0.02 lux, F1.0 AXIS P1354/-E: Color: 0.1 lux, F1.2, B/W: 0.02 lux, F1.2 AXIS P1355/-E: Color: 0.2 lux, F1.2, B/W: 0.04 lux, F1.2 AXIS P1357/-E: Color: 0.2 lux, F1.2, B/W: 0.04 lux, F1.2	Event actions	File upload: FTP, HTTP, network share and email; notification: email, HTTP and TCP; external output activation; pre- and post-alarm video buffering; video and audio recording to edge storage; PTZ preset; guard tour; play audio clip; day/night switching; status LED activation
Shutter time	AXIS P1353/-E, P1354/-E: Power line frequency 50 Hz: 1/24500 s to 2 s Power line frequency 60 Hz: 1/29500 s to 2 s AXIS P1355/-E: Power line frequency 50 Hz: 1/28000 s to 2 s Power line frequency 60 Hz: 1/33500 s to 2 s AXIS P1357/-E: Power line frequency 50 Hz: 1/24000 s to 2 s Power line frequency 60 Hz: 1/24000 s to 2 s	Data Streaming	Event data
Video		Built-in installation aids	Focus assistant, remote back focus, pixel counter
Video compression	H.264 (MPEG-4 Part 10/AVC) H.264 Baseline and Main Profile Motion JPEG	General	
Resolutions	AXIS P1353/-E: 800x600 (SVGA) to 160x90 AXIS P1354/-E: 1280x960* (approx. 1.3 MP) to 160x90 AXIS P1355/-E: 1920x1080 (HDTV) to 160x90 AXIS P1357/-E: 2592x1944 (5 MP) to 160x90 *1400x1050 (1.4 MP) scaled resolution available via VAPIX®	Casing	AXIS P1353/P1354/P1355/P1357: Metal (zinc) AXIS P1353-E/P1354-E/P1355-E/P1357-E: IP66- and NEMA 4X-rated, IK10 impact-resistant aluminum enclosure. Color: white NCS S 1002-B
Frame rate H.264/ Motion JPEG	AXIS P1353/-E, P1354/-E, P1355/-E: 25/30 fps with power line frequency 50/60 Hz AXIS P1357/-E: 5 MP capture mode: 12.5/12 fps with power line frequency 50/60 Hz 3 MP capture mode: 16/20 fps with power line frequency 50/60 Hz HDTV 1080p and 2 MP 4:3 (1600x1200) capture mode: 25/30 fps with power line frequency 50/60 Hz	Memory	256 MB RAM, 128 MB Flash AXIS P1357/-E: 512 MB RAM, 128 MB Flash
Video streaming	Multiple, individually configurable streams in H.264 and Motion JPEG Controllable frame rate and bandwidth VBR/CBR H.264	Power	AXIS P1353/P1354/P1355/P1357: 8–28 V DC or Power over Ethernet (PoE) IEEE 802.3af AXIS P1353/P1354: max. 7.2 W, PoE Class 3 AXIS P1355: max. 7.1 W, PoE Class 3 AXIS P1357: max. 7.9 W, PoE Class 3 AXIS P1353-E/P1354-E/P1355-E/P1357-E: Power over Ethernet (PoE) IEEE 802.3af max. 12.95 W or High PoE max 25.5 W
Multi-view streaming	AXIS P1355/-E and AXIS P1357/-E: Up to 8 individually cropped out view areas. AXIS P1357/-E: When streaming 4 view areas and 1 overview in VGA resolution, the frame rate is 12 fps per stream (5 MP capture mode) or 20 fps per stream (3 MP capture mode)	Connectors	RJ45 10BASE-T/100BASE-TX PoE IO: 4-pin 2.50 mm terminal block, for 1 alarm input and 1 output RS-485/422, 2 pcs, 2 pos, full duplex, terminal block DC input, terminal block 3.5 mm mic/line in, 3.5 mm line out AXIS P1353/-E, AXIS P1354/-E: DC-iris connector AXIS P1355/-E, AXIS P1357/-E: P-iris connector (compatible with DC-iris)
Image settings	Compression, color, brightness, sharpness, contrast, white balance, exposure control, exposure zones, backlight compensation, fine tuning of behavior at low light, WDR – dynamic contrast Text and image overlay, privacy mask, mirroring of images AXIS P1353/P1354/P1355/P1357: Rotation: 0°, 90°, 180°, 270° including Corridor Format	Edge storage	MicroSD/microSDHC/microSDXC slot supporting memory card up to 64 GB (card not included). Support for recording to network share (network-attached storage or file server)
Audio		Operating conditions	AXIS P1353/P1354/P1355/P1357: 0 °C to 50 °C (32 °F to 122 °F), humidity 10 – 85% RH (non-condensing) AXIS P1353-E/P1354-E/P1355-E/P1357-E: -30 °C to 50 °C (-22 °F to 122 °F) with PoE; down to -40 °C (-40 °F) with High PoE, humidity 10 – 100% RH (condensing)
Audio streaming	Two-way, full duplex	Approvals	EN 55022 Class B, EN 55024, EN/IEC/UL 60950-1, EN 61000-6-1, EN 61000-6-2, FCC Part 15 Subpart B Class B, ICES-003 Class B, VCCI Class B, C-tick AS/NZS CISPR 22, KCC KN22 Class B, KN24 AXIS P1353-E/P1354-E/P1355-E, P1357-E: EN 50121-4/IEC 62236, IEC 60529 IP66, NEMA 250 Type 4X, EN 60950-22, IEC 62262, IK10, IEC60950-22, UL60950-22, IEC 60068-2-6, IEC 60068-2-27
Audio compression	AAC LC 8/16 kHz, G.711 PCM 8 kHz, G.726 ADPCM 8 kHz Configurable bit rate	Weight	AXIS P1353/P1354/P1355/P1357: 0.6 kg (1.3 lb.) AXIS P1353-E/P1354-E/P1355-E/P1357-E: 3.1 kg (6.8 lb.)
Audio input/output	External microphone, input or line input, line output. AXIS P1353/P1354/P1355/P1357: Built-in microphone (can be disabled)	Included accessories	Connector kit, Installation Guide, Windows decoder 1-user license, Installation and Management Software CD AXIS P1353/1354/P1355/P1357: Stand AXIS P1353-E/P1354-E/P1355-E/P1357-E: Wall mount bracket, sunshield

** This product includes software developed by the OpenSSL Project for use in the OpenSSL Toolkit. (www.openssl.org)

Technical Specifications – AXIS P13 Network Camera Series

Dimensions: AXIS P13 Network Cameras

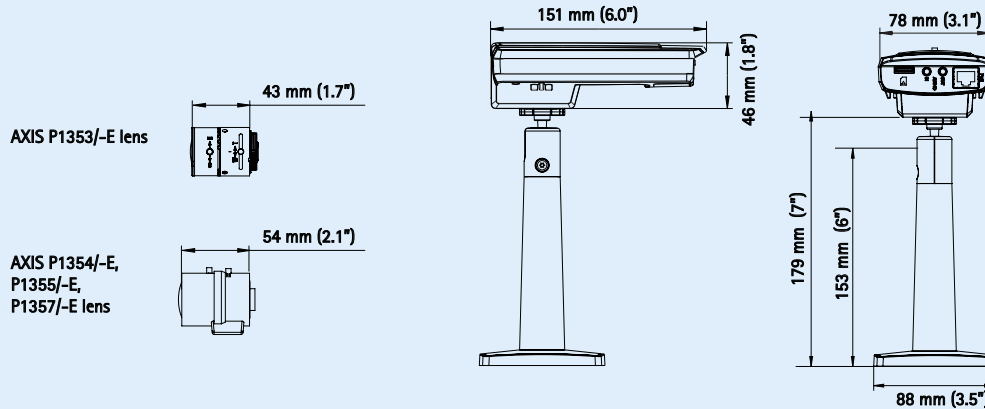

Dimensions: AXIS P13-E Network Cameras and wall mount bracket with internal cable channel

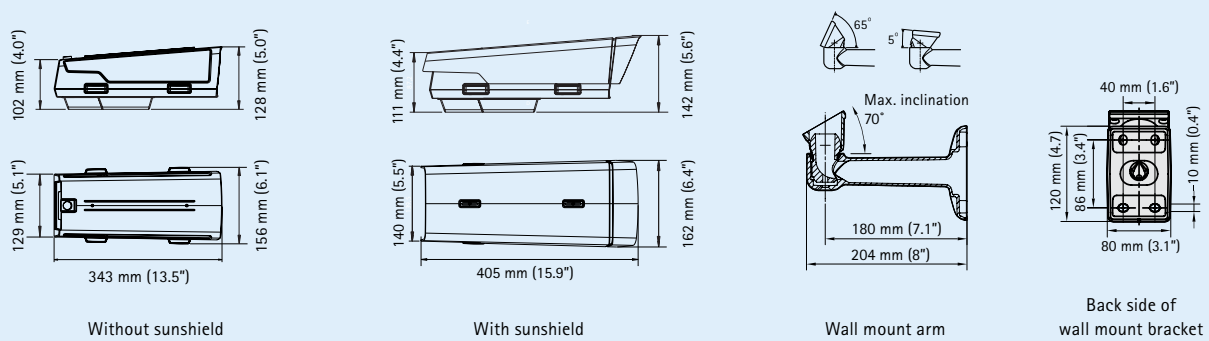

Optional accessories

AXIS T8120 Midspan 15 W 1-port



AXIS T8123 High PoE 30 W Midspan 1-port



AXIS T90A Illuminators



Lenses



AXIS T8414 Installation Display



AXIS Camera Companion (included), AXIS Camera Station and video management software from Axis' Application Development Partners (not included). For more information, see www.axis.com/products/video/software

Optional mounting accessories for outdoor models

Wall bracket accessories

Adapter plate



Pole mount



Corner mount



Ceiling brackets with ball joint



Column mount with ball joint

