



## Features

- 100x Zoom(10x Optical / 10x Digital)
- 127 Preset positions
- Pan/Tilt maximum rotating speed is 360°/sec
- Electronic sensitivity-up (DSS)
- TDN(ICR)
- Dual Stream MJPEG / H.264(or MPEG4)  
Resolution D1 up to 30(25)fps
- Vector Point Moving Function
- Support Two-way Audio (ADPCM)
- Support Local Storage by SD Memory Card
- Ethernet 10/100 Base-T

## XNET Applications



### Plug & Easy Play over IP

XNET supports plug and play with wizard installer. Auto system configuration and easily user setup by XNET applications.

- Simple install for network and systems setup
- Simultaneously systems setup
- Support UPnP, Bonjour for easy installation



### XNET CMS / XNET NVR

CNB XNET CMS/ NVR is the world first software that combines alarm monitoring and video surveillance seamlessly

- Multi-level user group / Interactive E-Map
- User-friendly windows-shell design with docking station utility panels
- Interactive Control, Triple monitors
- Easy to Use, All-in-One screen
- Compatible with various NVS, IP Camera, NVR in a System



### XNET APP (XNET Alliance Partner Program)

CNB XNET Products support Open-API for partners. Supplying a dynamic SDK based on API for various IP security environment. Join hands with XNET Alliance Partner Program, you can make a stable and strong IP security environment with improving your CMS and NVR.



#### [SDK Package Items]

- Sample Program and System Library for debug
- Release Mode Sample Method
- Documentation for SDK
- Sample Header File
- Library(debug/release)
- Sample Source Code (by Visual Studio 2005)

## Dimensions

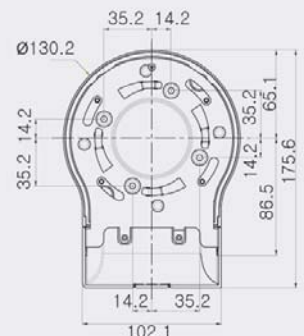
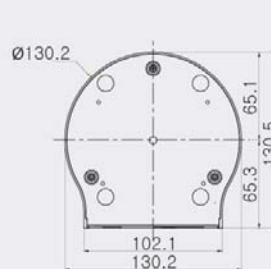
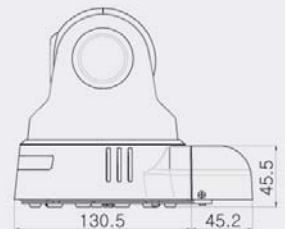
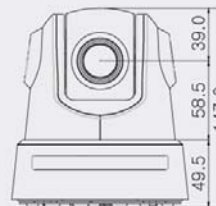

# XNET Main Feature



## Hybrid IP Technology

XNET can support Hybrid technology. At a standard analog CCTV BNC composite connection for CCTV system. At the same time, monitoring image over IP.

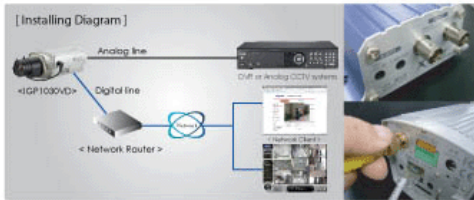

## Dynamic Dual Stream

XNET can support dual streaming for multi-client. H.264(or MPEG4) and MJPEG images can be output at the same time. User can see live monitoring with H.264(or MPEG4) and MJPEG based high quality stream image saving to storage.

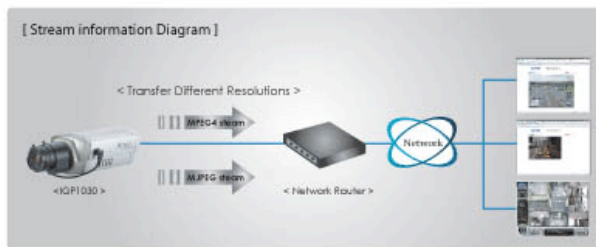

## Multiple Event Trigger

XNET also includes activity motion / sensor detection. Easily defined event setting and on-screen display. Activity detection events, XNET supports trigger event output over IP and can save the event image.

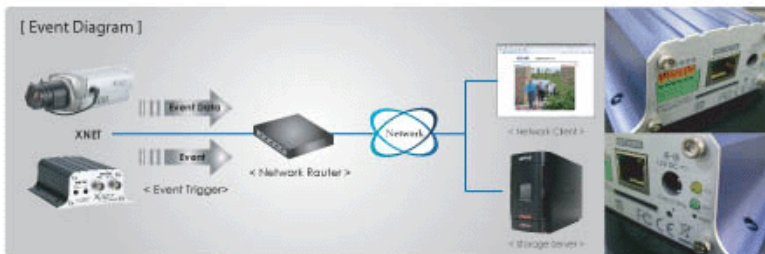

## Built-in PoE(Power over Ethernet)

Saving the installation cost, just do connect the cable to a PoE network hub or PoE network adaptor for easy installation with XNET IP product. CNB all IP products are standard IEEE 802.3af supported. (Optional)

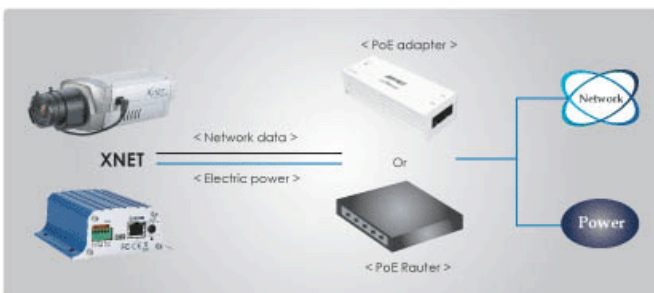

## Specifications

	Model	IPM3063N	IPM3063P
Camera	Signal System	NTSC	PAL
	Scanning System	2:1 Interface	
	Scanning Frequency (H) / (V)	15.734kHz / 59.94Hz	15.625kHz / 50Hz
	Image Sensor	1/4 inch Super HAD CCD	
	Sync. System	Internal	
	Total / Effective Pixels Number	410K / 380K	470K / 440K
	Horizontal Resolution	500 TV Lines	
	Video Output Level	1.0Vp-p (75Ω, composite)	
	S/N Ratio	More than 50dB (AGC off)	
	Lens	10x Optical Zoom Lens	
	Min. Illumination	0.7Lux(Color), 0.005Lux(Sens-up), 0.02Lux (BW) 30IRE	
	Day & Night System	Electronic Sensitivity-up (DSS), ICR (Sensor type), DNR	
	Privacy Zone	Control On/Off(4 Zone setting) over IP	
	OSD Menu	Control On/Off over IP	
	White Balance	Auto	
	Preset	127 Positions with labels	
	Functions	8 Swings, 4 Patterns, 8 Groups	
	Panning/Tilting Range, Speed	Pan: 360° endless rotation; Tilt: 90°, Manual: 1° ~ 360°/sec; Preset: 360°/sec; Swing: 1°~180°/sec	
	Electronic Shutter Speed	1/60~1/120,000sec	1/50~1/120,000sec
System	Main Processors	32bit Embedded CPU with Linux	
	System Memory	NAND Flash Memory : 64MByte, 128MB DDR Memory	
Video / Audio	Compression	MJPEG / MPEG4 / H.264	
	Frame rate	Dual Mode : MJPEG (15fps) / MPEG4 / H.264 (30fps)	
	Resolution	D1 (704x480), CIF (352 x 240)	
	Video streaming	MJPEG / MPEG4(or H.264) Dual mode Constant and variable bit rate in MPEG4 (128kbps ~ 3M bps), Controllable frame rate and bandwidth	
	Image settings	Compression level setting, Configurable Brightness, Sharpness, White Balance	
	Audio	Two-way (Full duplex / ADPCM G.726)	
Network	Protocol	IPv4, HTTP, TCP, RTSP, RTP, RTCP, UDP,SMTP, FTP, ICMP, DHCP, UPnP, Bonjour, ARP, DNS, DynDNS	
	Supported DDNS	1.CNB DDNS 2.DynDNS.org 3.Reference code with SDK	
	Video Access from Web browser	Camera live viewer for up to 10 clients	
Security	Access Level Setup	Multiple user access levels with password protection	
	Network Security	IP Filtering	
Alarm and Event Management	Image Detection	Motion detection (Select 3 Regions - each area)	
	Sensor Detection	Sensor In, Scheduling, Alarm out	
	After Event Process	JPEG Image upload over FTP server / SMTP (E-mail server)	
	Local Storage	JPEG Image write to Internal memory	
		JPEG Image write to Internal & SD card memory - Internal memory : Max 32MByte, SD memory : Support size Max 4GByte	
Pre/Post Alarm	Detail time-set : Max Pre alarm 5 sec / Post alarm 8 sec, Local storage (Internal memory or SD card memory : JPEG image)		
	Local storage (Internal memory : JPEG image)		
Applications	Browser	Internet Explorer 6.0 over	
	Language Support	*Plan : Will support Unicode for multi-language	
	Monitoring Application	Web Viewer (Window Web Browser Base) / Live view for up to 10 user clients	
		Video Snapshot & recording to file (JPEG file) XNVR Viewer and Utility (IP-Installer, etc)	
Maintenance	System Upgrade	Firmware upgrade over HTTP (Network Module), Speed Dome Mechanism (Update stick)	
Mechanical	Operating Temperature	-30℃ ~ 50℃	
	Power	DC12V/1.2A, 10W	
	Dimensions	Dome: 130.2(W) x 130.5(D) x 142.1(H) mm	
	Weight (Net)	Approx. 1kg	