

GV-MFD1501 1.3MP H.264 Super Low Lux WDR Mini Fixed Dome



- 1.3" Megapixel Progressive Scan super low lux CMOS
- Megapixel lens
- Min. illumination at 0.01 lux
- Dual streams from H.264 and MJPEG
- Up to 30 fps at 1280 x 1024
- Wide Dynamic Range (WDR)
- DC 5V / PoE (IEEE 802.3af)
- USB slot for [GV-WiFi Adaptor](#) or USB hard drive
- Two-way audio
- Built-in micro SD card slot (SD/SDHC) for local storage
- Recording assigned by GV-Edge Recording Manager ([Windows](#), [Mac](#) version)
- Day and night function (electronic)
- Tampering alarm
- 3D noise reduction
- Defog
- Motion detection
- Privacy mask
- IP address filtering
- iPhone, iPad, Android
- Supports iPhone, iPad, Android & 3GPP
- 31 languages on Web interface
- ONVIF (Profile S) conformant
- More Storage Option - [NAS](#)

* No Memory card slot & local storage function for Argentina.

Introduction

The GV-MFD1501 Series are indoor, fixed, mini-sized network cameras with various lens options. The cameras are equipped with Super Low Lux CMOS image sensors capable of providing color live view in low-light conditions. The cameras' USB ports support wireless connection through GV-WiFi Adapter (optional) and external storage using USB hard drives.

Active Tampering Alarm

Tampered



Focus Change

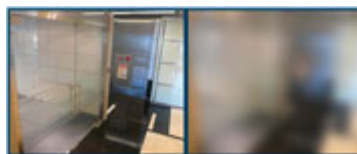

Camera Shift

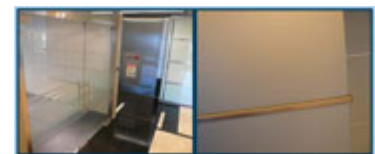

Models

Models	Iris	Focal Length (mm)	Maximum Aperture	Image Format
MFD1501-0F	Fixed	2.8 mm	F/2.0	1/3"
MFD1501-1F		4 mm	F/1.5	
MFD1501-2F		8 mm	F/1.6	
MFD1501-3F		12 mm	F/1.6	
MFD1501-4F		2.1 mm	F/1.8	
MFD1501-5F		3.8 mm	F/1.8	

Dimensions

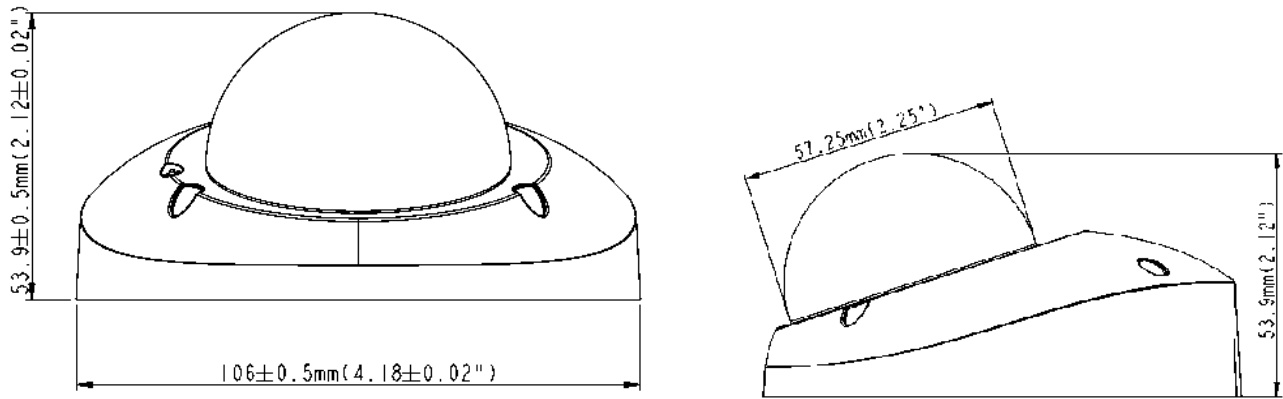

Specifications

Camera	GV-MFD1501 -0F	GV-MFD1501 -1F	GV-MFD1501 -2F	GV-MFD1501 -3F	GV-MFD1501 -4F	GV-MFD1501 -5F
Image Sensor	1/3" progressive scan super low lux CMOS					
Picture Elements	1280 (H) x 1024 (V)					
Minimum Illumination	0.01 Lux					
Shutter Speed	Automatic, Manual (1/5 ~ 1/8000 sec.)					
White Balance	Automatic, Manual (2800K ~ 8500K)					
Gain Control	Automatic					
S/N Ratio	55 dB					
WDR	Yes					
Lens						
Megapixel	Yes					
Day/Night	Yes (Electronic)					
Iris	Fixed					
Focal Length	2.8 mm	4 mm	8 mm	12 mm	2.1 mm	3.8 mm
Maximum Aperture	F/2.0	F/1.5	F/1.6	F/1.6	F/1.8	F/1.8
Mount	M12, Pitch 0.5 mm					
Image Format	1/3"					
Horizontal FOV	87°	67°	35°	22°	124°	64°
Operation	Focus	Fixed				
	Zoom	Fixed				
	Iris	Fixed				
Operation						
Video Compression	H.264, MJPEG					
Video Streaming	Dual streams from H.264 and MJPEG					
Frame Rate	30 fps at 1280 x 1024 (60/50 Hz) * The frame rate and the performance may vary depending on the number of connections and data bitrates (different scenes).					
Image Setting	Brightness, Contrast, Saturation, Sharpness, Gamma, White Balance, Flicker-less 50/60 Hz, Image Orientation, Shutter Speed, Backlight Compensation, D/N Sensitivity, WDR, Defog, Super Low Lux, Noise Reduction, Metering					
Audio Compression	G.711, AAC (optional)					
Audio Support	Two-Way Audio					
Sensor Input	N/A					
Alarm Output	N/A					

Video Resolution		
Main Stream	4:3	1280 x 960, 640 x 480, 320 x 240
	16:9	1280 x 720, 640 x 360, 448 x 252
	5:4	1280 x 1024 (Default), 640 x 512, 320 x 256
Sub Stream	4:3	640 x 480, 320 x 240
	16:9	640 x 360, 448 x 252
	5:4	640 x 512, 320 x 256 (Default)
Network		
Interface	10/100 Ethernet	
Ethernet Protocol	DHCP, DynDNS, FTP, HTTP, HTTPS, NTP, ONVIF (Profile S), QoS (DSCP), RTSP, SNMP, SMTP, TCP, UDP, UPnP, 3GPP/ISMA	
Mechanical		
Temperature Detector	Yes	
Camera Angle Adjustment	Pan	-45° ~ 45°
	Tilt	0° ~ 90°
Connectors	Power	2-pin terminal block, PoE
	Ethernet	Ethernet (10/100 Base-T), RJ-45
	Audio	1 In (built-in microphone), 1 Out (RCA female for speaker)
	USB	GV-WiFi Adaptor or USB hard drive
	Local Storage	Micro SD card slot (SD/SDHC, SD version 2.0 only, Class 10) * SDXC and UHS-I card types are not supported.
LED Indicator	4 LEDs: Link, ACT, Power, Status	
General		
Camera Housing	black, white	
Environment Temperature	0 °C ~ 50 °C (32 °F ~ 122 °F)	
Humidity	10% to 90% (no condensation)	
Power Source	5V DC/PoE (IEEE 802.3af)	
Max. Power Consumption	6 W	
Dimension	ø 106 x 53.9 mm (4.2" x 2.1")	
Weight	280 g (0.62 lb)	
Regulatory	CE, FCC, RCM, RoHS compliant	
Power over Ethernet		
PoE Standard	PoE (IEEE 802.3af Power over Ethernet / PD)	
PoE Power Supply Type	End-Span	
PoE Power Output	Per Port 48V DC, 350mA. Max. 15.4 watts	
Web Interface		
Installation Management	Web-based configuration	
Maintenance	Firmware upgrade through Web Browser or Utility	
Access from Web Browser	Camera Live View, Video Recording, Change Video Quality, Bandwidth Control, Image Snapshot, Audio, Picture in Picture, Picture and Picture, Privacy Mask, Text Overlay, Digital PTZ	
Language	Arabic / Bulgarian / Czech / Danish / Dutch / English / Finnish / French / German / Greek / Hebrew / Hungarian / Indonesian / Italian / Japanese / Lithuanian / Norwegian / Persian / Polish / Portuguese / Romanian / Russian / Serbian / Simplified Chinese / Slovakian / Slovenian / Spanish / Swedish / Thai / Traditional Chinese / Turkish	
Applications		
Network Storage	GV-DVR/NVR, GV-Backup Center, GV-Recording Server, GV-VMS	
Smart Device Access	GV-Eye for iOS and Android	
Live Viewing	IE, Mobile App	
CMS Server support	GV-Control Center, GV-Center V2, GV-Vital Sign Monitor	

Note:

- Mind the following limitations and requirements for the USB port:
 - The USB hard drive must be of 2.5" or 3.5", version 2.0 or above.
 - The USB hard drive's storage capacity must not exceed 2 TB.
 - USB flash drives and USB hubs are not supported.
 - External power supply is required for using an USB hard drive.
 - To connect the GV-WiFi Adaptor, make sure it is connected before the camera is powered on.



2. Mind the following when using an inserted memory card for recording:
 - Recorded data on the memory card can be damaged or lost if the data are accessed while the camera is under physical shock, power interruption, memory card detachment or when the memory card reaches the end of its lifespan. No guarantee is provided for such causes.
 - The stored data can be lost if the memory card is not accessed for a prolonged period of time. Back up your data periodically if you seldom access the memory card.
 - Memory cards are expendable and their durability varies according to the conditions of the installed site and how they are used. Back up your data regularly and replace the memory card annually.
 - To avoid power outage, it is highly recommended to apply a battery backup (UPS).
 - For better performance, it is highly recommended to use Micro SD card of MLC NAND flash, Class 10.
 - Replace the memory card when its read/write speed is lower than 6 MB/s or when the memory card is frequently undetected by the camera.
3. Specifications are subject to change without notice.



Packing List

- | | |
|---------------------------|--------------------------|
| 1. Mini Fixed Dome | 6. Short-Body RJ-45 Plug |
| 2. Torx Wrench | 7. USB / Audio Y-cable |
| 3. Self Tapping Screw x 2 | 8. Power Adapter |
| 4. Screw Anchor x 2 | 9. Download Guide |
| 5. Cable Stopper | 10. Warranty Card |

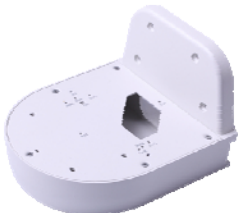
Note: The power adapter can be excluded upon request.

Accessories

Model No./Name	Details
 GV-Mount909 Wall Mount Bracket	Dimensions: 170 x 150 x 110 mm (6.7" x 5.9" x 4.3") Weight: 610 g (1.34 lb)
 GV-Mount910 Power Box Mount Bracket	Dimensions: 112 x 98 x 7.5 mm (4.4" x 3.9" x 0.3") Weight: 105 g (0.23 lb)
 GV-Mount913 Power Box Mount Bracket	Dimensions: Ø 146 x 7.5 mm (Ø 5.7" x 0.3") Weight: 180 g (0.4 lb)

Model No./Name	Details
GV-Mount918 Wall Mount Bracket for MFD/MDR/EFD/EDR 	Dimensions: Ø 145 x 117 x 96 mm (Ø 5.71" x 4.60" x 3.78") Weight: 350 g (0.77 lb)
GV-PA191 PoE Adapter 	Dimensions (H x W x D): 43 x 69 x 40 mm (1.69" x 2.72" x 1.57") Weight: 130 g (0.29 lb)
Power Adapter	Contact our sales representatives for the countries and areas supported.
GV-PoE Switch	GV-PoE Switch is designed to provide power along with network connection for IP devices. GV-PoE Switch is available in various models with different numbers and types of ports.
GV-WiFi Adaptor V2	GV-WiFi Adaptor V2 is designed to connect GV-IP devices to the wireless network.