

GV-MFD2700 Series 2MP H.265 Super Low Lux WDR Pro IR Mini Fixed Dome



- 1/2.8" progressive scan super low lux CMOS
 - Min. illumination at 0.004 lux
 - Dual streams from H.265, H.264 and MJPEG
 - Up to 30 fps at 1920 x 1080
 - Two-way audio
 - Intelligent IR
 - 3-axis mechanism (pan / tilt / rotate)
 - One sensor input and alarm output
 - Built-in micro SD card slot (SD/SDHC/SDXC/UHS-I) for local storage
 - Day and night function (with removable IR-cut filter)
 - Megapixel lens
 - 12V DC / PoE (IEEE 802.3af)
 - Wide Dynamic Range Pro (WDR Pro)
 - 3D noise reduction
 - Smart streaming
 - Defog
 - Motion detection
 - Tampering alarm
 - Text overlay
 - Privacy mask
 - IP address filtering
 - Recording assigned by GV-Edge Recording Manager ([Windows](#), [Mac](#) version)
 - Supports iPhone, iPad, Android & 3GPP
 - 31 languages on Web interface
 - ONVIF (Profile S) conformant
- * No Memory card slot & local storage function for Argentina.
* Smart streaming requires either GV-DVR / NVR V8.7.0.0 or GV-VMS V16.10.3.0

Introduction

GV-MFD2700 Series offers an indoor, fixed, mini-sized network camera with 3-axis mechanism for easy and flexible installation. The camera can support H.265 video codec to achieve better compression ratio while maintaining high picture quality at reduced network bandwidths. GV-MFD2700 can process scenes with contrasting intensity of lights and produce clear image using the built-in WDR Pro. The camera is equipped with a Super Low Lux CMOS image sensor which allows the camera to provide a color live view in near darkness.

Models

Models	Iris	Focal Length (mm)	Maximum Aperture	Image Format
GV-MFD2700-0F	Fixed	2.8 mm	F/2.0	1/2.7"
GV-MFD2700-2F		3.8 mm	F/1.8	
GV-MFD2700-6F		2.3 mm	F/2.2	

Active Tampering Alarm

Tampered



Focus Change



Camera Shift

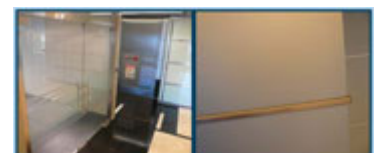

Dimensions

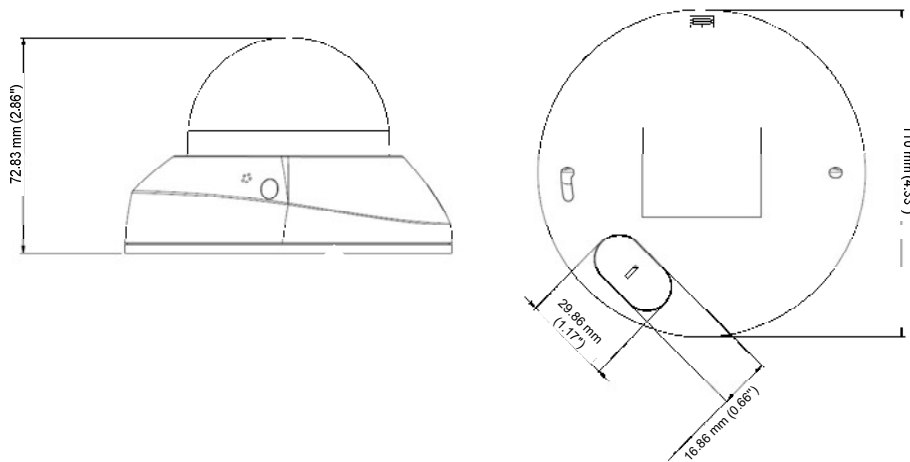

Specifications

Camera	GV-MFD2700-0F	GV-MFD2700-2F	GV-MFD2700-6F
Image Sensor	1/2.8" progressive scan super low lux CMOS		
Picture Elements	1920 (H) x 1080 (V)		
Minimum Illumination	Color	0.005 Lux	
	B/W	0.004 Lux	
	IR ON	0 Lux	
Shutter Speed	Automatic, Manual (1/5 ~ 1/16000 sec)		
White Balance	Automatic, Manual (2800 ~ 8500K)		
Gain Control	Automatic		
S/N Ratio	56 dB		
WDR Pro	Yes		
Dynamic Range	Up to 130 dB		
Lens			
Megapixel	Yes		
Day/Night	Yes (with removable IR-cut filter)		
Lens Type	Fixed		
Focal Length	2.8 mm	3.8 mm	2.3 mm
Maximum Aperture	F/2.0	F/1.8	F/2.2
Mount	M12, Pitch 0.5 mm		
Image Format	1/2.7"		
Horizontal FOV	100°	72°	140°
Operation	Focus	Fixed	
	Zoom	Fixed	
	Iris	Fixed	
IR LED Quantity	4 IR LEDs		
Max. IR Distance	20 m (65.6 ft)		
Operation			
Video Compression	H.265, H.264, MJPEG		
Video Streaming	Stream 1 from H.265 or H.264 Stream 2 from H.265, H.264 or MJPEG		
Frame Rate	50 Hz: 25 fps at 1920 x 1080 60 Hz: 30 fps at 1920 x 1080 * The frame rate and performance may vary depending on the number of connections and data bitrates (different scenes).		
Image Setting	Brightness, Contrast, Saturation, Sharpness, Gamma, White Balance, Flicker-less, Image Orientation, Shutter Speed, Backlight Compensation, D/N Sensitivity, WDR, Defog, Low Lux Enhancement, Denoise, Metering		
Audio Compression	G.711, AAC (Optional)		
Audio Support	Two-way audio		
Sensor Input	1 input (dry contact)		
Alarm Output	1 digital output (200 mA 5V DC)		

Video Resolution		
	4:3	1280 x 960, 640 x 480
Main Stream	16:9	1920 x 1080 (Default), 1280 x 720, 640 x 360
	5:4	1280 x 1024, 640 x 512
Sub Stream	4:3	1024 x 768, 640 x 480, 320 x 240
	16:9	1280 x 720, 640 x 360 (Default), 448 x 256
	5:4	1280 x 1024, 640 x 512, 320 x 256
Network		
Interface	10/100 Ethernet	
Protocol	DHCP, DNS, DynDNS, FTP, HTTP, HTTPS, ICMP, IPv4, NTP, ONVIF (Profile S), QoS (DSCP), RTSP, RTP, RTCP, SNMP, SMTP, SSL, TCP/IP, UDP, UPnP, 3GPP/ISMA	
Mechanical		
Temperature Detector	Yes	
Camera Angle Adjustment	Pan	-45° ~ 45°
	Tilt	0° ~ 70°
	Rotate	0° ~ 360°
Connectors	Power	2-pin terminal block (DC 12V, 1.25A), PoE
	Ethernet	Ethernet (10/100 Base-T), RJ-45 cable
	Audio	1 In (built-in or external microphone) 1 Out (stereo phone jack, 3.5 mm / 0.14")
	Digital I/O	I/O wires
	Local Storage	Micro SD card slot (SD/SDHC/SDXC/UHS-I, Class 10) *UHS-II card type is not supported.
LED Indicator	2 LEDs: Power, Status	
General		
Environment Temperature	Start-up	0°C ~ 50°C (32°F ~ 122°F)
	Operation	
Humidity	10% to 90% (no condensation)	
Power Source	12V DC / PoE (IEEE 802.3af)	
Max. Power Consumption	12V DC, 6.5W	
Dimensions (without lens)	110 x 72.83 mm (4.33" x 2.86")	
Weight	200 g (0.44 lb)	
Regulatory	CE, FCC, RCM, LVD, RoHS compliant	
Power over Ethernet		
PoE Standard	PoE (IEEE 802.3af Power over Ethernet / PSE)	
PoE Power Supply Type	End-Span and Mid-Span	
PoE Power Output	Per Port 48V DC, 350 mA, Max. 15.4 watts	
Web Interface		
Installation Management	Web-based configuration	
Maintenance	Firmware upgrade through Web Browser or Utility	
Access from Web Browser	Camera Live View, Video Recording, Change Video Quality, Bandwidth Control, Image Snapshot, Audio, Picture in Picture, Picture and Picture, Privacy Mask, Text Overlay, Digital PTZ	
Language	Arabic / Bulgarian / Czech / Danish / Dutch / English / Finnish / French / German / Greek / Hebrew / Hungarian / Indonesian / Italian / Japanese / Lithuanian / Norwegian / Persian / Polish / Portuguese / Romanian / Russian / Serbian / Simplified Chinese / Slovakian / Slovenian / Spanish / Swedish / Thai / Traditional Chinese / Turkish	
Applications		
Software Supported	GV-DVR / NVR (V8.7.1.0), GV-VMS (V15.11.3.0), GV-Edge Recording Manager (V1.2.0.0), GV-Center V2 (V15.10.0.0), GV-Recording Server (V1.3.0.0), GV-Redundant / Failover Server (V1.1.0.0)	
Smart Device Access	GV-Eye for iOS and Android	
Live Viewing	Browser (IE, Chrome, Firefox, Safari), Mobile app	
CMS Server support	GV-Control Center, GV-Center V2, GV-Vital Sign Monitor	

Note:





1. It is required to apply patch files to all the supported software.
2. The signal range and data throughput may vary depending on the network conditions and environmental factors.
3. Mind the following when using a memory card for recording:
 - Recorded data on the memory card can be damaged or lost if the data are accessed while the camera is under physical shock, power interruption, memory card detachment or when the memory card reaches the end of its lifespan. No guarantee is provided for such causes.

- The stored data can be lost if the memory card is not accessed for a long period of time. Back up your data periodically if you seldom access the memory card.
 - Memory cards are expendable and their durability varies according to the conditions of the installed site and how they are used. Back up your data regularly and replace the memory card annually.
 - To avoid power outage, it is highly suggested to apply a battery backup (UPS).
 - For better performance, it is highly suggested to use Micro SD card of MLC NAND flash, Class 10.
 - Replace the memory card when its read/write speed is lower than 6 MB/s or when the memory card is frequently undetected by the camera.
4. Specifications are subject to change without notice.

Packing List

- | | |
|---|---------------------------------|
| 1. H.265 Mini Fixed IP Dome | 6. Audio and I/O extended cable |
| 2. Screw x 2 | 7. Torx Wrench |
| 3. Screw Anchor x 2 | 8. Download Guide |
| 4. Focus Adjustment Ring
(only for GV-MFD2700-0F/2F) | 9. Warranty Card |
| 5. Installation Sticker | |

Accessories

Model No.	Name		Details
GV-Mount910	Power Box Mount Bracket		Dimensions: 112 x 98 x 7.5 mm (4.4" x 3.9" x 0.3") Weight: 105 g (0.23 lb)
GV-Mount913	Power Box Mount Bracket		Dimensions: Ø 146 x 7.5 mm (Ø 5.7" x 0.3") Weight: 180 g (0.4 lb)
GV-Mount918	Wall Mount Bracket for MFD/MDR/EFD/EDR		Dimensions: Ø 145 x 117 x 96 mm (Ø 5.71" x 4.60" x 3.78") Weight: 350 g (0.77 lb)
GV-PA191	PoE Adapter		The GV-PA191 is a Power over Ethernet (PoE) adapter designed to provide power to the IP device through a single Ethernet cable.
GV-Relay V2			The GV-Relay V2 is designed to expand the voltage load of GV IP devices. It provides 4 relay outputs, and each can be set as normally open (NO) or normally closed (NC) independently as per your requirement.
GV-POE Switch			The GV-POE Switch is designed to provide power along with network connection for IP devices. The GV-POE Switch is available in various models with different numbers and types of ports.
Power Adapter			Contact our sales representatives for the countries and areas supported.