



## Key Features

- 2 MP high performance COMS
- Ultra-Low Light
- 1920 × 1080 resolution
- 2.8 mm, 3.6 mm, 6 mm fixed focal lens
- 120 dB true WDR, 3D DNR
- EXIR 2.0, Smart IR, up to 20 m IR distance
- IP67
- Up the Coax (HIKVISION-C)



## Specification

<b>Camera</b>	
Image Sensor	2.0 megapixel progressive scan CMOS
Signal System	PAL/NTSC
Frame Rate	PAL: 1080p@25fps NTSC: 1080p@30fps
Resolution	1920 (H) × 1080 (V)
Min. illumination	Color: 0.005 Lux @ (F1.2, AGC ON), 0 Lux with IR
Shutter Time	PAL: 1/25 s to 1/50, 000 s NTSC: 1/30 s to 1/50, 000 s
Slow Shutter	Max. 16 times
Lens	2.8 mm, 3.6 mm, 6 mm fixed focal lens
Horizontal Field of View	103.5° (2.8 mm), 82.6° (3.6 mm), 54.4° (6 mm)
Lens Mount	M12
Day & Night	IR cut filter
Angle Adjustment	Pan: 0° to 360°, Tilt: 0° to 75°, Rotate: 0° to 360°
Synchronization	Internal synchronization
WDR (Wide Dynamic Range)	> 120 dB
<b>Menu</b>	
AGC	Support
Day/Night Mode	Auto/Color/BW (Black and White)
White Balance	ATW/MANUAL
Privacy Mask	ON/OFF, 4 programmable privacy masks
Motion Detection	4 programmable motion areas
Backlight Compensation	WDR/BLC/OFF
3D DNR (Digital Noise Reduction)	Level 1 to 10
Language	English, Chinese
Functions	Brightness, Sharpness, Mirror, Smart IR
<b>Interface</b>	
Video Output	1 HD analog output
<b>General</b>	
Operating Conditions	-40 °C to 60 °C (-40 °F to 140 °F), humidity: 90% or less (non-condensation)
Power Supply	12 VDC ±25%
Power Consumption	Max. 3.6 W
Ingress Protection	IP67
Material	Metal
IR Range	Up to 20 m
Communication	Up the coax, Protocol: HIKVISION-C (TVI output)
Dimensions	91 mm × 82.6 mm × 68.3 mm (3.58" × 3.25" × 2.69")
Weight	Approx. 350 g (0.77 lb.)

**Order Models**

DS-2CE56D8T-ITM

**Dimension**

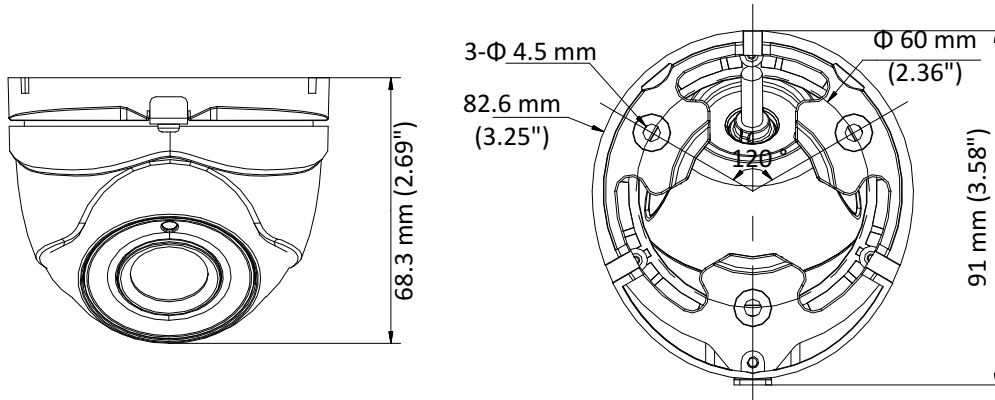

**Accessory**



DS-1280ZJ-XS  
Junction Box



DS-1272ZJ-110-TRS  
Wall Mounting Bracket



DS-1276ZJ-SUS  
Corner Mounting Bracket



DS-1275ZJ-SUS  
Vertical Pole Mounting Bracket



DS-1H18  
Video Balun

Distributed by



**HIKVISION**

**Headquarters**

No.555 Qianmo Road, Binjiang District,  
Hangzhou 310051, China  
T +86-571-8807-5998  
overseasbusiness@hikvision.com

**Hikvision USA**  
T +1-909-895-0400  
sales.usa@hikvision.com

**Hikvision Europe**  
T +31-23-55-42-770  
info.eu@hikvision.com

**Hikvision Middle East**  
T +971-4-8816086  
salesme@hikvision.com

**Hikvision Russia**  
T +7-495-669-67-99  
saleru@hikvision.com

**Hikvision India**  
T +91-22-28469900  
sales@pramahikvision.com

**Hikvision Italy**  
T +39-0438-6902  
info.it@hikvision.com

**Hikvision France**  
T +33(0)1-85-330-450  
info.fr@hikvision.com

**Hikvision Spain**  
T +34-91-737-16-55  
info.es@hikvision.com

**Hikvision Poland**  
T +48-22-460-01-50  
poland@hikvision.com

**Hikvision UK**  
T +01628-902140  
support.uk@hikvision.com

**Hikvision Singapore**  
T +65-6684-4718  
sg@hikvision.com

**Hikvision Oceania**  
T +61-2-8599-4233  
salesau@hikvision.com

**Hikvision Canada**  
T +1-909-895-0400  
sales.usa@hikvision.com

**Hikvision Korea**  
T +82-31-731-8841  
sales.korea@hikvision.com

**Hikvision Brazil**  
T +55 11 3318-0050  
Latam.support@hikvision.com

**Hikvision Africa**  
T +27 (0) 0351172  
sale.africa@hikvision.com

**Hikvision Hong Kong**  
T +852-2151-1761