

## DS-2CE57D3T-VPITF 2 MP EXIR Dome Camera



### Key Features

- 2 MP high-performance CMOS
- Ultra low light
- 1920 × 1080 resolution
- 2.8 mm, 3.6 mm, 6 mm fixed lens
- EXIR 2.0, smart IR, up to 30 m IR distance
- OSD menu, 3D DNR, 120 dB true WDR, day/night switch
- 4 in 1 video output (switchable TVI/AHD/CVI/CVBS)
- IP67, IK10
- Up the coax (HIKVISION-C)



## Specifications

<b>Camera</b>	
Image Sensor	2.0 megapixel progressive scan CMOS
Signal System	PAL/NTSC
Video Frame Rate	PAL: 1080p@25fps NTSC: 1080p@30fps
Resolution	1920 (H) x1080 (V)
Min. Illumination	0.005 Lux@(F1.2, AGC ON), 0 Lux with IR
Shutter Time	PAL: 1/25 s to 1/50, 000 s NTSC: 1/30 s to 1/50, 000 s
Lens	2.8 mm, 3.6 mm, 6 mm
Horizontal Field of View	106° (2.8 mm), 82° (3.6 mm), 51° (6 mm)
Lens Mount	M12
Day & Night	IR cut filter
Angle Adjustment	Pan: 0° to 355°, Tilt: 0° to 75°, Rotation: 0° to 355°
Synchronization	Internal synchronization
WDR (Wide Dynamic Range)	≥ 120 dB
<b>Menu</b>	
AGC	High/Medium/Low
D/N Mode	Auto/Color/BW (Black and White)
Image Mode	STD/HIGH-SAT
BLC (Backlight Compensation)	Yes
WDR	Yes
3D DNR	Level 1 to 9
Language	English
Functions	Brightness, Sharpness, 3D DNR, Mirror, Smart IR
<b>Interface</b>	
Video Output	1 HD analog output
Switch Button	TVI/AHD/CVI/CVBS
<b>General</b>	
Operating Conditions	-40 °C to 60 °C (-40 °F to 140 °F), Humidity: 90% or less (non-condensation)
Power Supply	12 VDC ±25%
Power Consumption	Max. 4.6 W
Protection Level	IP67, IK10
Material	Metal
IR Range	Up to 30 m
Dimensions	Ø 111 mm × 82.4 mm (Ø 4.4" × 3.2")
Weight	Approx. 487 g (1.07 lb.)

**Order Model**

DS-2CE57D3T-VPITF

**Dimension**

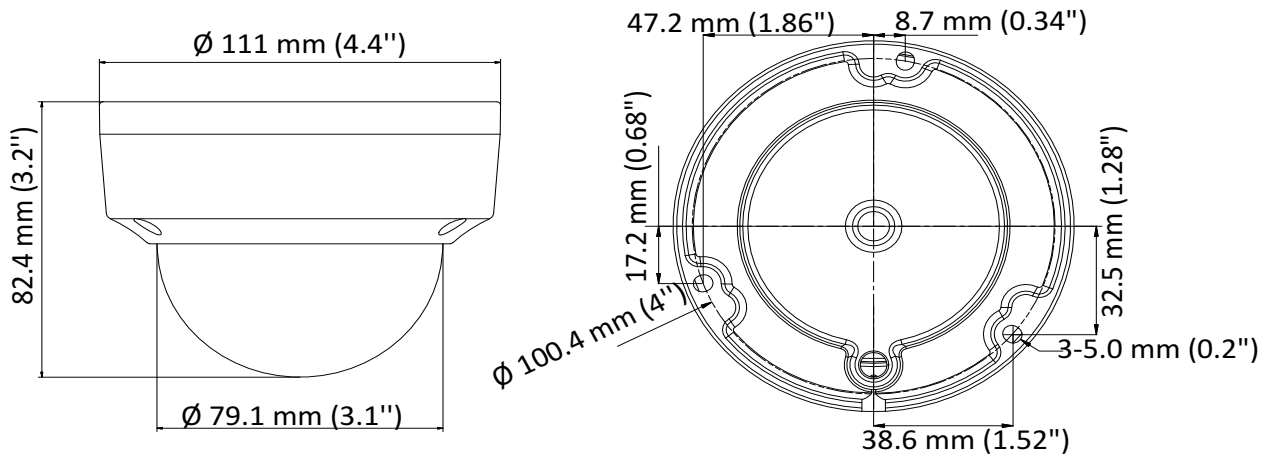

## Accessory



**DS-1259ZJ**  
Inclined Ceiling Mount

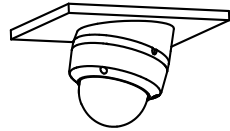

**DS-1271ZJ-110**  
Pendant Mount

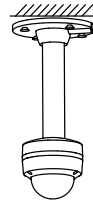

**DS-1272ZJ-110B**  
Wall Mount

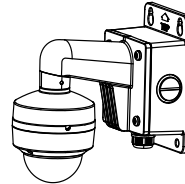

**DS-1272ZJ-110**  
Wall Mount



**DS-1280ZJ-DM18**  
Junction Box

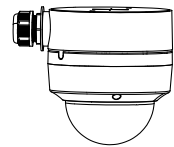

**DS-1258ZJ**  
Wall Mount

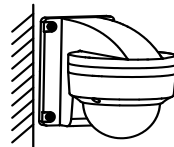

**DS-1275ZJ-SUS**  
Vertical Pole Mount

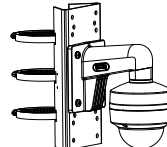

Distributed by



## HIKVISION®

### Headquarters

No.555 Qianmo Road, Binjiang District,  
Hangzhou 310051, China  
T +86-571-8807-5998  
overseasbusiness@hikvision.com

**Hikvision USA**  
T +1-909-895-0400  
sales.usa@hikvision.com

**Hikvision Europe**  
T +31-23-5542770  
sales.eu@hikvision.com

**Hikvision UK & Ireland**  
T +01628-902140  
sales.uk@hikvision.com

**Hikvision UAE**  
T +971-4-4432090  
salesme@hikvision.com

**Hikvision Russia**  
T +7-495-669-67-99  
saleru@hikvision.com

**Hikvision Australia**  
T +61-2-8599-4233  
salesau@hikvision.com

**Hikvision Italy**  
T +39-0438-6902  
info.it@hikvision.com

**Hikvision South Africa**  
Tel: +27 (10) 0351172  
sale.africa@hikvision.com

**Hikvision Singapore**  
T +65-6684-4718  
sg@hikvision.com

**Hikvision Korea**  
T +82-(0)31-731-8817  
sales.korea@hikvision.com

**Hikvision India**  
T +91-22-28469900  
sales@pramahikvision.com

**Hikvision Brazil**  
T +55 11 3318-0050  
Latam.support@hikvision.com

**Hikvision France**  
T +33(0)1-85-330-450  
info.fr@hikvision.com

**Hikvision Spain**  
T +34-91-737-16-55  
info.es@hikvision.com

**Hikvision Poland**  
T +48-22-460-01-50  
info.pl@hikvision.com

**Hikvision Canada**  
T +1-866-200-6690  
sales.canada@hikvision.com

**Hikvision Turkey**  
T +90 (216)521 7070- 7074  
sales.tr@hikvision.com

**Hikvision Kazakhstan**  
T +7-727-9730667  
nikia.panfilov@hikvision.uz

**Hikvision Tashkent**  
T +99-87-1238-9438  
uzb@hikvision.ru

**Hikvision Indonesia**  
T +62-21-2933759  
Sales.Indonesia@hikvision.com

**Hikvision Thailand**  
T +662-275-9949  
sales.thailand@hikvision.com

**Hikvision Malaysia**  
T +601-7652-2413  
sales.my@hikvision.com

**Hikvision Vietnam**  
T +84-974270888  
sales.vt@hikvision.com

**Hikvision Hong Kong**  
T +852-2151-1761  
info.hk@hikvision.com

**Hikvision Colombia**  
sales.colombia@hikvision.com