

## DS-2CE5AH0T-(A)VPIT3ZF 5 MP Dome Camera



### Key Features

- 5 MP high performance COMS
- 2560 × 1944 resolution
- 2.7 mm to 13.5 mm motorized vari-focal lens
- EXIR 2.0, smart IR, up to 40 m IR distance
- OSD menu, 2D DNR, DWDR
- 4 in 1 video output (switchable TVI/AHD/CVI/CVBS)
- IP67, IK10
- Up the coax (HIKVISION-C)



## Specification

<b>Camera</b>	
Image Sensor	5 MP CMOS image sensor
Resolution	2560 (H) × 1944 (V)
Min. Illumination	Color: 0.01 Lux @ (F1.2, AGC ON), 0 Lux with IR
Shutter Time	PAL: 1/25 s to 1/50, 000 s NTSC: 1/30 s to 1/50, 000 s
Lens	2.7 mm to 13.5 mm motorized vari-focal lens
Horizontal Field of View	95.7° to 29.1°
Lens Mount	Φ 14
Day & Night	IR cut filter
Angle Adjustment	Pan: 0° to 355°; Tilt: 0° to 75°; Rotate: 0° to 355°
Synchronization	Internal synchronization
Frame Rate	PAL: 5 MP@20fps, 4 MP@25fps, 1080p@25fps NTSC: 5 MP@20fps, 4 MP@30fps, 1080p@30fps
<b>Menu</b>	
AGC	Support
D/N Mode	Auto/Color/BW (Black and White)
White Balance	ATW/MWB
BLC	Support
DWDR (Digital Wide Dynamic Range)	Support
Functions	Brightness, Sharpness, DNR, Mirror, Smart IR
<b>Interface</b>	
Video Output	1 HD analog output
Switch Button	TVI/AHD/CVI/CVBS
<b>General</b>	
Operating Conditions	-40 °C to 60 °C (-40 °F to 140 °F), humidity: 90% or less (non-condensation)
Power Supply	12 VDC ±15%, 24 VAC ±15%
Power Consumption	DS-2CE5AH0T-VPIT3Z: Max. 4.4 W DS-2CE5AH0T-AVPIT3Z: Max. 6.0 W
Protection Level	IP67, IK10
Material	Metal
IR Range	Up to 40 m
Communication	Up the coax, Protocol: HIKVISION-C (TVI output)
Dimensions	∅ 145 mm × 111.3 mm (∅ 5.70" × 4.37")
Weight	DS-2CE5AH0T-VPIT3ZF: Approx. 815 g (1.80 lb.) DS-2CE5AH0T-AVPIT3ZF: Approx. 860 g (1.90 lb.)

**Order Model**

DS-2CE5AH0T-VPIT3ZF, DS-2CE5AH0T-AVPIT3ZF

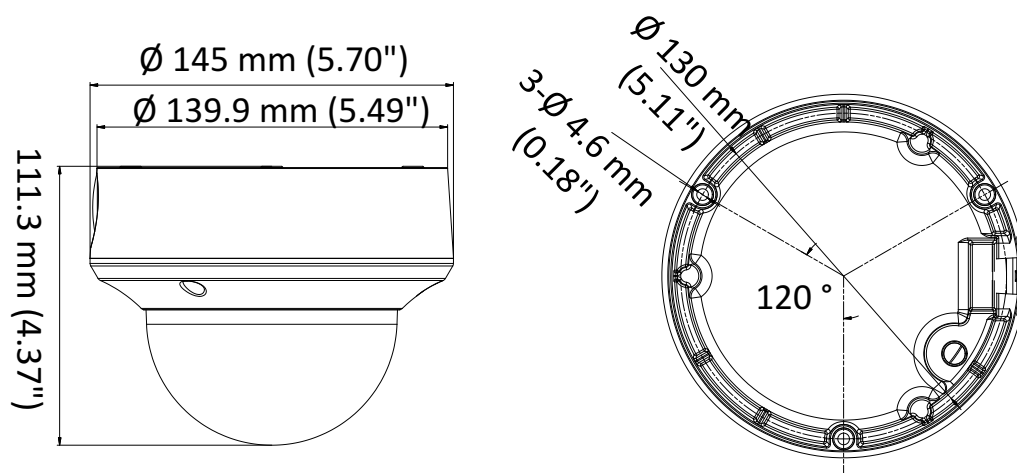
**Dimension**

## Accessory

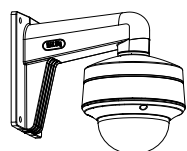

**DS-1273ZJ-140-DM45**  
Wall Mount

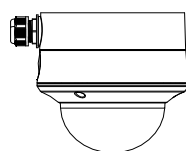
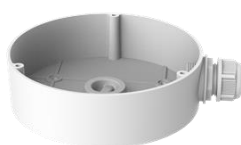

**DS-1280ZJ-DM45**  
Junction Box

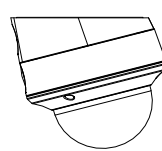

**DS-1281ZJ-DM45**  
Inclined Ceiling Mount

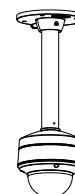

**DS-1271ZJ-140-DM45**  
Pendant Mount

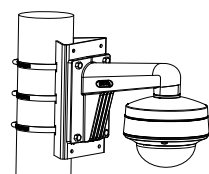

**DS-1275ZJ-SUS**  
Vertical Pole Mount

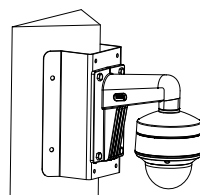

**DS-1276ZJ-SUS**  
Corner Mount

Distributed by



## HIKVISION®

### Headquarters

No.555 Qianmo Road, Binjiang District,  
Hangzhou 310051, China  
T +86-571-8807-5998  
overseasbusiness@hikvision.com

**Hikvision USA**  
T +1-909-895-0400  
sales.usa@hikvision.com

**Hikvision Italy**  
T +39-0438-6902  
info.it@hikvision.com

**Hikvision Singapore**  
T +65-6684-4718  
sg@hikvision.com

**Hikvision Africa**  
T +27 (10) 0351172  
sale.africa@hikvision.com

**Hikvision Europe**  
T +31-23-55-42-770  
info.eu@hikvision.com

**Hikvision France**  
T +33(0)1-85-330-450  
info.fr@hikvision.com

**Hikvision Oceania**  
T +61-2-8599-4233  
salesau@hikvision.com

**Hikvision Hong Kong**  
T +852-2151-1761

**Hikvision Middle East**  
T +971-4-8816086  
salesme@hikvision.com

**Hikvision Spain**  
T +34-91-737-16-55  
info.es@hikvision.com

**Hikvision Canada**  
T +1-909-895-0400  
sales.usa@hikvision.com

**Hikvision Russia**  
T +7-495-669-67-99  
saleru@hikvision.com

**Hikvision Poland**  
T +48-22-460-01-50  
poland@hikvision.com

**Hikvision Korea**  
T +82-31-731-8841  
sales.korea@hikvision.com

**Hikvision India**  
T +91-22-28469900  
sales@pramahikvision.com

**Hikvision UK**  
T +01628-902140  
support.uk@hikvision.com

**Hikvision Brazil**  
T +55 11 3318-0050  
Latam.support@hikvision.com