

# Industrial Renewable Energy 4-Port 10/100/1000T 802.3at PoE+ Managed Ethernet Switch



## Industry-leading Integration of PoE Technology and Renewable Power System

PLANET's newly-launched Renewable Energy Industrial 802.3at PoE Managed Ethernet Switch, BSP-360, is designed for deploying a surveillance or wireless network and remotely monitoring and managing the IP-based devices. Based on its green technology, the BSP-360 can be charged by the inexhaustible and natural source of energy, such as solar, wind and hydroelectric power to conserve energy so as to economically power these remote IP cameras and wireless APs, especially used for such expansive applications as dams, forests, deserts, national parks, nature/animal protection areas and highways.



## Zero-Carbon and Stable Power Supply

The BSP-360 utilizes the solar power sourcing and co-works with the common nickel-cadmium battery or lead-acid battery to form an independent solar power supply system for outdoor network system. The BSP-360 delivers zero-carbon and uninterruptible PoE power supply for continuous outdoor wireless and IP surveillance applications without the need of any cabling. It can power the client devices and can be charged at the same time during the day to enable to continue the operation at night.

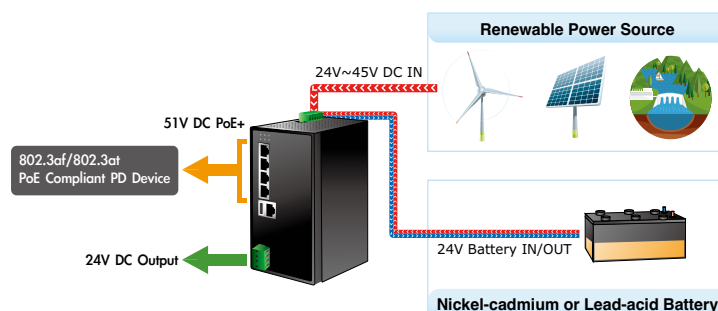

## Physical Port

- 5-port 10/100/1000BASE-T Gigabit RJ45 copper with 4-port IEEE 802.3at/af PoE Injector (Port 1 to Port 4)
- RJ45 type interface for basic management and setup
- USB type A female for setting file backup and restore

## Power over Ethernet

- Complies with IEEE 802.3at Power over Ethernet Plus end-span PSE
- Backward compatible with IEEE 802.3af Power over Ethernet
- Up to 4 ports of IEEE 802.3af/802.3at devices powered
- Supports PoE power up to 30 watts for each PoE port
- Auto detects powered device (PD)
- Circuit protection prevents power interference between ports
- Remote power feeding up to 100 meters
- PoE management
  - Total PoE power budget control
  - Per port PoE function enable/disable
  - PoE port power feeding priority
  - Per PoE port power limitation
  - PD alive-check
  - PoE schedule

## Battery Management

- Battery type option: Nickel-cadmium battery or lead-acid battery
- Easy diagnostic of the system operating status via LED indicator
- Battery current usage and status
- Battery capacity and power consumption statistics
- Low voltage cut-off protection: Send alert and cut off the low priority PoE port for the low power battery
- Pulse Width Modulation (PWM) Protection
  - Reverse current protection to prevent the current circuits from flowing back to the PV panel
  - Over-current and over-temperature protection
  - Reverse polarity protection (for battery and charging electrodes)

## Industrial Case & Installation

- IP30 aluminum case
- DIN-rail and wall-mounted design
- Supports -10 to 60 degrees C operating temperature

### Built-in Unique Power Functions for Battery Management

As it is the power managed for battery and power consumption, the BSP-360 features the following special power management functions:

- Battery current usage and status
- Battery capacity statistics
- Low voltage cut-off protection

### Battery Current Usage status and Statistics

The administrator can remotely access the BSP-360 to know the power status of the battery and renewable energy, and the estimated time of power consumption.

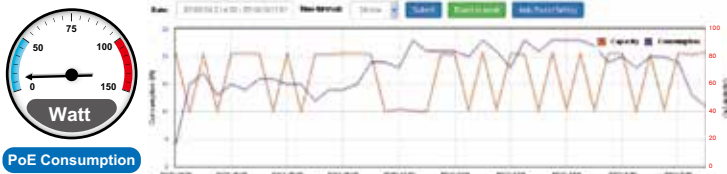

### Low Voltage Cut-Off Protection

If the power is too low to empower the system and IP devices, the system will automatically power off the device with low priority to make sure the system works normally, and an alert is then sent to the administrator at the same time.

#### Status A: Normal Operation

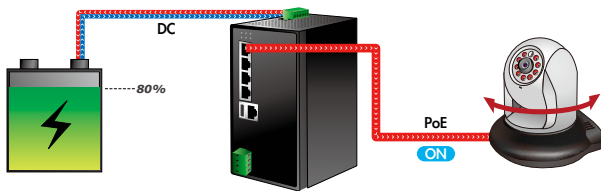

#### Status B: Middle Battery Capacity

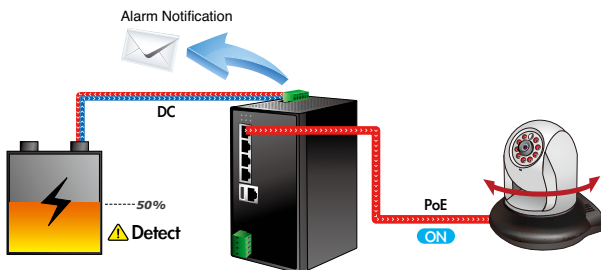

#### Status C: Low Battery Capacity

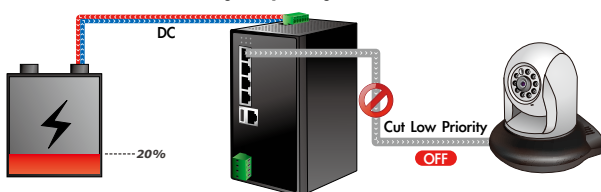

- Supports ESD 6KV DC Ethernet protection
- Redundant power design
  - 24V~45V DC wide power input

### Switching

- Hardware based 10/100Mbps (half/full duplex), 1000Mbps (full duplex), auto-negotiation and auto MDI/MDI-X
- Features Store-and-Forward mode with wire-speed filtering and forwarding rates
- IEEE 802.3x flow control for full duplex operation and back pressure for half duplex operation
- 8K MAC address table size
- Automatic address learning and address aging

### Router

- Internet types: Dynamic IP, static IP, PPPoE, L2TP, PPTP
- Static and dynamic (RIP1 and 2) routing
- IP/MAC-based bandwidth control
- Supports Port Forwarding, DMZ, UPnP and Dynamic DNS for various networking applications
- 802.1d STP and IGMP Proxy

### Security

- Port filtering lets you either allow or prevent which applications can access the Internet.
- MAC filtering allows you to include or exclude computers and devices based on their MAC address
- URL filtering allows you to control access to Internet websites in an URL list
- IP source guard prevents IP spoofing attacks
- DoS attack prevention

### Management

- Switch Management Interface
  - IPv4 Web switch management
  - SNMP v1, v2c
- Static and DHCP for IP address assignment
- System Maintenance
  - Firmware upload/download via HTTP
  - Configuration upload/download through HTTP
  - Hardware reset button for system reboot or reset to factory default
- NTP Network Time Protocol
- SNMP trap for interface Link Up and Link Down notification
- Event message logging to remote syslog server
- PLANET Smart Discovery Utility

**Built-in Unique PoE Functions for Powered Devices Management**

As it is the managed PoE switch for surveillance, wireless and VoIP networks, the BSP-360 features the following special PoE management functions:

- PD alive check
- Scheduled power recycling
- PoE schedule
- PoE usage monitoring

**Intelligent Powered Device Alive Check**

The BSP-360 can be configured to monitor connected PD (Powered Device) status in real time via ping action. Once the PD stops working and responding, the BSP-360 will resume the PoE port power and bring the PD back to work. It will greatly enhance the network reliability through the PoE port resetting the PD's power source and reducing administrator management burden.

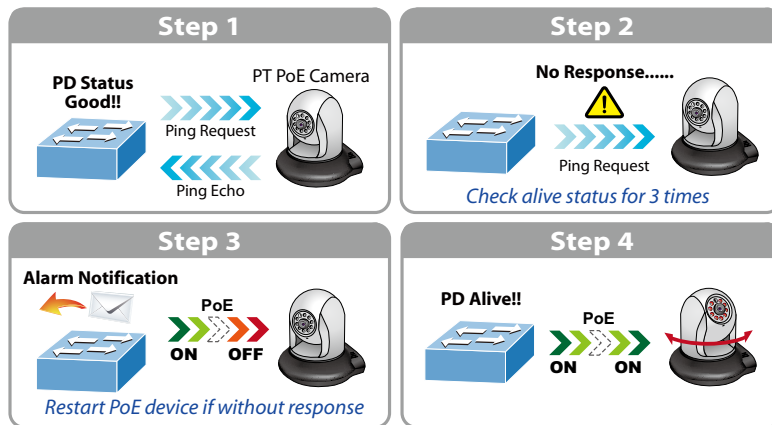

**Scheduled Power Recycling**

The BSP-360 allows each of the connected PoE IP cameras or PoE wireless access points to reboot at a specific time each week. Therefore, it will reduce the chance of IP camera or AP crash resulting from buffer overflow.

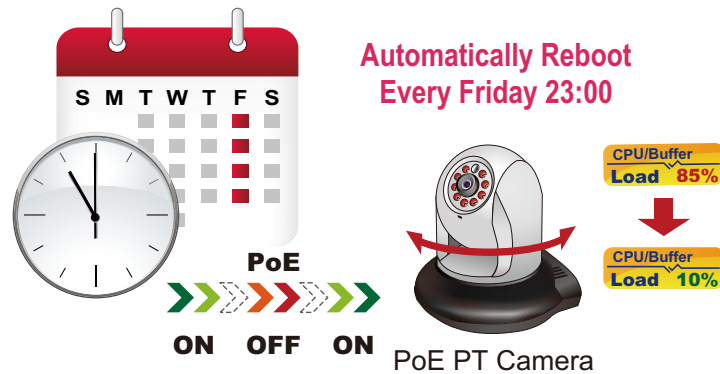

**PoE Schedule for Energy Saving**

Under the trend of energy saving worldwide and contributing to environmental protection, the BSP-360 can effectively control the power supply besides its capability of giving high watts power. The "PoE schedule" function helps you to enable or disable PoE power feeding for each PoE port during specified time intervals and it is a powerful function to help SMBs or enterprises save power and budget. It also increases security by powering off PDs that should not be in use during non-business hours.

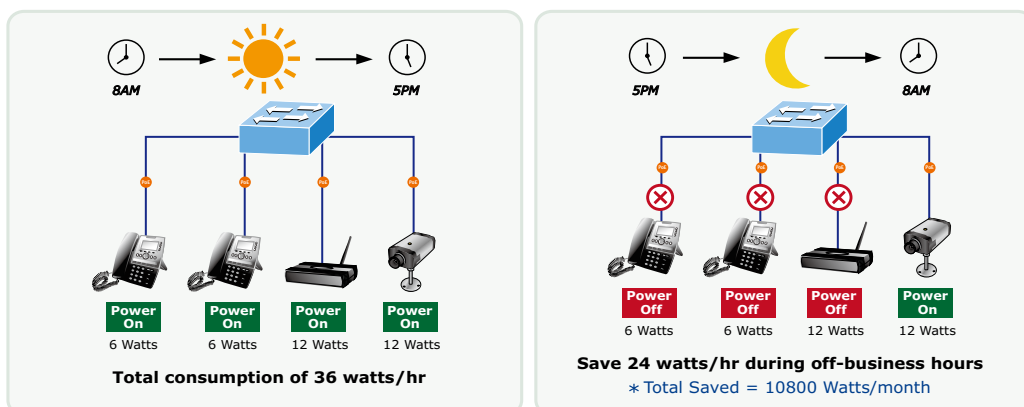

### *PoE Usage Monitoring and Intelligent LED Indicator for Real-time PoE Usage*

Via the power usage chart in the web management interface, the BSP-360 enables the administrator to monitor the status of the power usage of the connected PDs in real time. Thus, it greatly enhances the management efficiency of the facilities. Moreover, the BSP-360 helps users to monitor the current status of PoE power usage easily and efficiently via its advanced LED indication. Called "PoE Power Usage", the front panel of the BSP-360 has three LED indicators of different power usages.

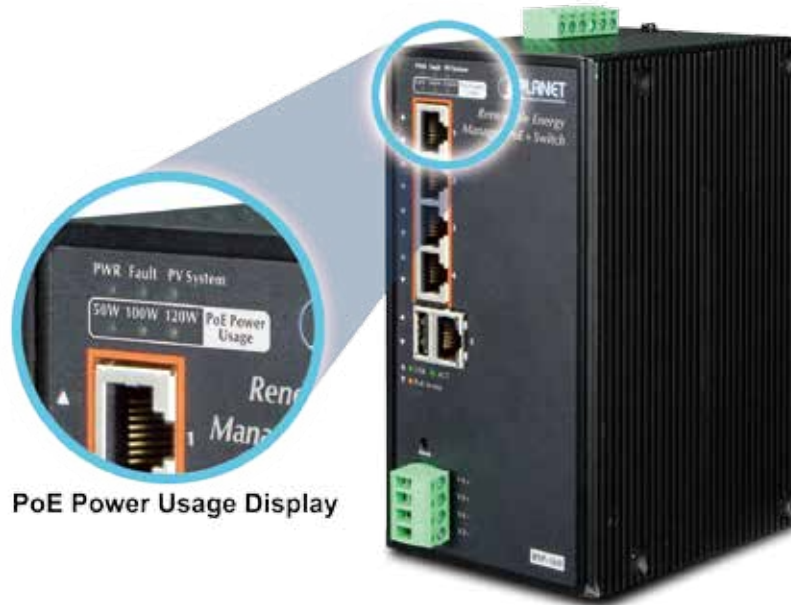

### *Friendly and Secure Management*

For efficient management, the BSP-360 is equipped with web and SNMP management interfaces. With the built-in web-based management interface, the BSP-360 offers an easy-to-use, platform-independent management and configuration facility. By supporting the standard SNMP, the switch can be managed via any standard management software.

## Applications

### Solar PoE Power Supply for Long Distance Wireless Surveillance Solution

Providing Plug-and-Play instant Internet service, the BSP-360 can be deployed anywhere in the city where there is no direct AC electricity. With PoE over the Cat5 cable, wireless AP and SFP media converter, you can check the current energy consumption and battery status in your office within the configuration interface of the BSP-360.

### SOHO / Home-Use Gigabit Ethernet PoE Network Deployment

With its expanded home-use feature, the BSP-360 Renewable Energy PoE Switch helps SOHO / home users to create an integrated network where power is so easily utilized for transmission of data and video. It integrates IEEE 802.3at PoE technology and renewable power system. The wireless AP and PoE IP camera devices work perfectly with the BSP-360, which injects power through the Ethernet cables, thus helping SOHO / home users to build a cost-effective and reliable PoE networking environment easily.

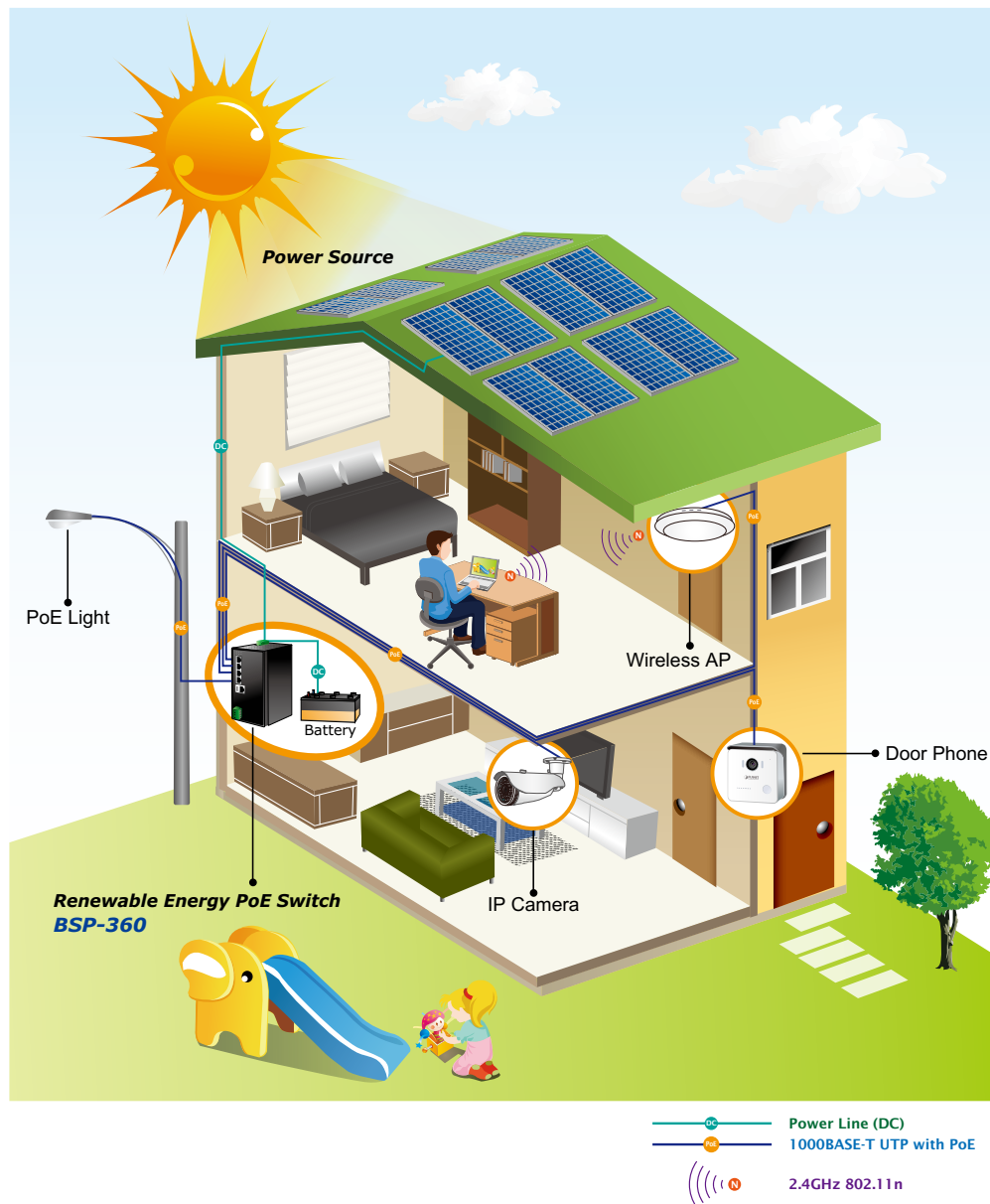

*Wireless Connection for Outdoor Long-range Application*

With the four 802.3at/802.3af PoE interfaces, the BSP-360 enables you to install the PoE access point in the outdoors freely. When functioning with a pair of the wireless transmission, the BSP-360 Renewable Energy PoE Switch can be efficiently managed from remote monitor center. It enables the wireless LAN deployment to become more flexible and worry-free from the power outlet locations.\*\*

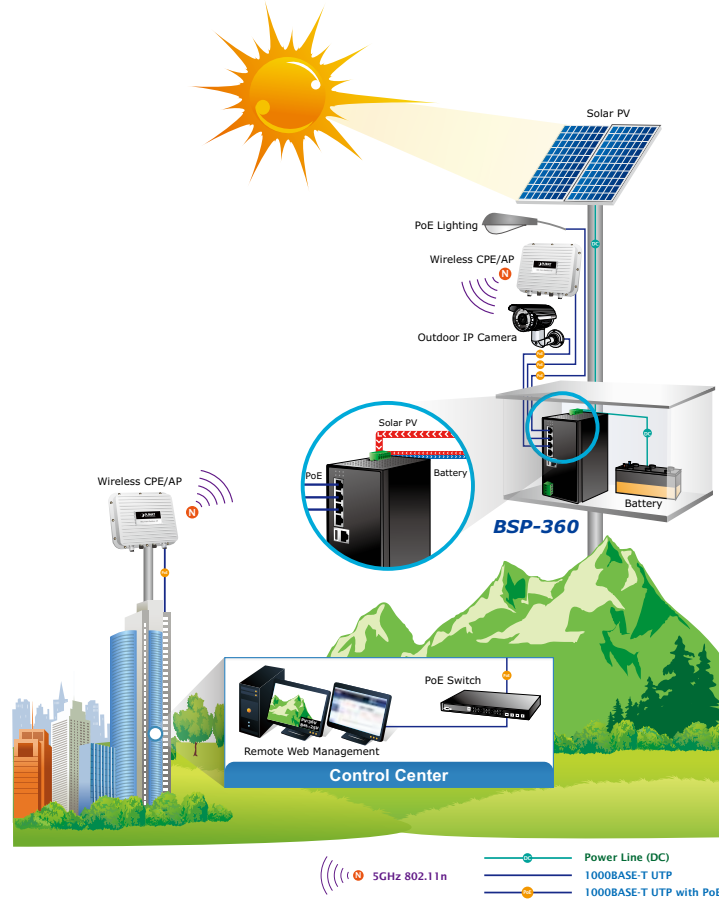

\*\*To get the best performance, match it with PLANET devices for outdoor wireless bridge applications.

*Enables Extension of Network Deployment with Fiber Media Converter*

With the 24VDC out interface, the BSP-360 enables you to supply power to other device, such as PLANET IGT-905A, that fiber media converter where high-speed and stable data transmission can be made to a remote core network. It can extend the distance to Max. 120 kilometers between BSP-360 and control center via Fiber-Optic Link.

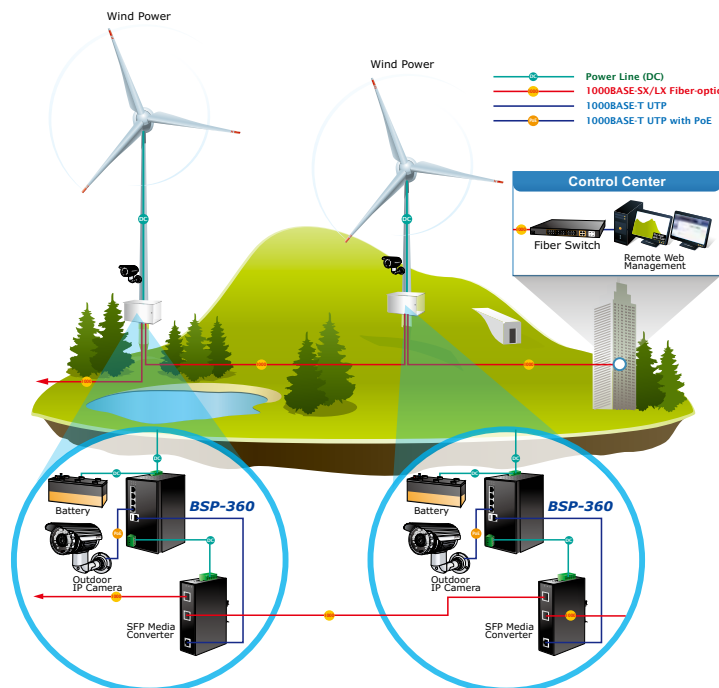

## Specifications

Product	BSP-360
<b>Hardware Specifications</b>	
Copper Ports	LAN: 5 10/100/1000Mbps auto MDI/MDI-X RJ45 port (Port 1 to Port 5, bridge mode) WAN: 1 10/100/1000Mbps auto MDI/MDI-X RJ45 port (Port 5, gateway mode)
PoE Injector Port	4 ports with 802.3af/802.3at PoE injector function (Port 1 to Port 4)
USB	1 USB Type A female for setting backup
Power Output	4 PoE out 51VDC; max. 30 watts per PoE port 2 DC out 24@ 1A maximum (four-pin terminal block) * The voltage of DC out is based on the battery.
Switch Architecture	Store-and-Forward
Switch Fabric	10Gbps/non-blocking
Switch Throughput@64 bytes	5.95Mpps@64 bytes
MAC Address Table	8K entries
Shared Data Buffer	512Kbit
Flow Control	IEEE 802.3x pause frame for full-duplex Back pressure for half-duplex
Reset Button	< 5 sec: System reboot > 5 sec: Factory default
LED	3 LEDs for System and Power: <ul style="list-style-type: none"> <li>■ Green: Power</li> <li>■ Green: Fault</li> <li>■ Green: System</li> </ul> 4 LEDs for PoE Copper Ports (Port 1~Port 4): <ul style="list-style-type: none"> <li>■ Green: LNK/ACT</li> <li>■ Orange: PoE-in-use</li> </ul> 1 LED for 10/100/1000T Copper Port (Port 5): <ul style="list-style-type: none"> <li>■ Green: LNK/ACT</li> </ul> 3 LEDs for PoE Power Usage (W) <ul style="list-style-type: none"> <li>■ Green: 50, 100 and 120W</li> </ul>
Connector	Removable 6-pin terminal block Pin 1/2 for PV panel; Pin 3/4 for alarm; Pin 5/6 for battery
Alarm	1 Digital Output (DO): Level 0: -24V~2.1V (±0.1V) Level 1: 2.1V~24V (±0.1V) Open collector to 24V DC, 100mA max.
Power Requirements	PV in: 24~45V DC Battery in/out: 24V DC
Power Consumption/ Dissipation	5.04 watts, 17.1BTU (Standby without PoE function) 6.96 watts, 23.7 BTU (Full loading without PoE function) 135.36 watts, 461.5 BTU (Full loading with PoE function)
Dimensions (W x D x H)	84 x 107 x 152 mm
Weight	1026g
ESD Protection	6KV DC
Enclosure	IP30 aluminum case
Installation	DIN-rail kit and wall-mount ear
<b>Power over Ethernet</b>	
PoE Standard	IEEE 802.3af/802.3at Power over Ethernet PSE
PoE Power Supply Type	End-span
PoE Power Output	Per port 51V DC, 275mA. Max. 15.4 watts (IEEE 802.3af) Per port 51V DC, 535mA. Max. 30 watts (IEEE 802.3at)
Power Pin Assignment	1/2 (+), 3/6 (-)
PoE Power Budget	120 watts (PoE consumption + DC out and depending on power input)
Max. Number of Class 2 PDs	4
Max. Number of Class 3 PDs	4
Max. Number of Class 4 PDs	4
<b>Electrical Characteristics</b>	
System Voltage Rating	24V DC
Maximum Charging Current	6A
Max. Solar Array VOC	60V DC
Max. Operating Voltage	45V DC
Total Current Consumption	While operating -32mA At idle -11mA

High Temperature Shutdown	100 degrees C disconnect solar and load 80 degrees C reconnect solar and load
<b>Battery Charging Characteristics</b>	
Charge Algorithm	Bulk charge (constant current), Absorption charge (constant voltage) and Floating charge. Absorption and Floating charge with PWM protection.
Maximum Output Current	6A
Nickel-cadmium Battery	± 40 mV/degrees Celsius for NiCad type batteries; charge cut-off @ 55 degrees C (Temperature compensation baseline@ 25 degrees C)
Lead Acid Battery (Default Setting)	± 60 mV/degrees Celsius for lead acid type batteries; charge cut-off @ 55 degrees C (Temperature compensation baseline@ 25 degrees C)
Float Charge Voltage	DC 27.2V (26.0~30.0V)
Absorption Charge Voltage	DC 29.2V (28.0~32.0V)
LVD (Low Voltage Disconnection)	DC 22.2V (21.0~25.0V)
LVR (Low Voltage Reconnection)	DC 24.8V (23.0~27.0V)
<b>Router Features</b>	
Internet Connection Type	Shares data and Internet access with users, supporting the following internet accesses: <ul style="list-style-type: none"> <li>■ PPPoE</li> <li>■ Dynamic IP</li> <li>■ Static IP</li> <li>■ PPTP</li> <li>■ L2TP</li> </ul>
Firewall	NAT firewall with SPI (Stateful Packet Inspection) Built-in NAT server supporting Port Forwarding, and DMZ Built-in firewall with IP address/MAC address/Port/ URL filtering Supports ICMP-FLOOD, UDP-FLOOD, TCP-SYN-FLOOD filter, DoS protection
Routing Protocol	Static/Dynamic (RIP1 and 2) routing
VPN Pass-through	PPTP, L2TP, IPSec, IPv6
LAN	Built-in DHCP server supporting static IP address distribution Supports UPnP, Dynamic DNS Supports IGMP Proxy Supports 802.1d STP (Spanning Tree) IP/MAC-based bandwidth control
<b>Management</b>	
Management Interface	Setup of system/management functions Web firmware upgrade SNMP trap for alarm notification of events
PoE Management	Power limit by consumption and allocation PoE admin mode Per port power schedule Per port power enable/disable Power feeding priority Current per port usage and status Total power consumption PD alive check Scheduled power recycling
Battery Management	Battery current usage and status Battery capacity statistics Low Voltage Cut-Off Protection
<b>Standards Conformance</b>	
Regulatory Compliance	FCC Part 15 Class A, CE
Standards Compliance	IEEE 802.3 10BASE-T Ethernet IEEE 802.3u 100BASE-TX Fast Ethernet IEEE 802.3ab 1000BASE-T Gigabit Ethernet IEEE 802.3x Flow Control and Back Pressure IEEE 802.1D Spanning Tree Protocol IEEE 802.3af Power over Ethernet IEEE 802.3at Power over Ethernet Plus RFC 768: UDP RFC 791: IP RFC 2068 HTTP RFC 1157: SNMP v1 RFC 1902: SNMP v2c RFC 5424: Syslog



Environment	
Operating	Temperature: -10 ~ 60 degrees C Relative Humidity: 5 ~ 95% (non-condensing)
Storage	Temperature: -10 ~ 70 degrees C Relative Humidity: 5 ~ 95% (non-condensing)

## Ordering Information

BSP-360	Industrial Renewable Energy 4-Port 10/100/1000T 802.3at PoE+ Managed Ethernet Switch
---------	--

## Related PoE Products

BSP-300	Industrial Solar Power PoE Switch
ICA-E3550V	5 Mega-pixel Bullet IR PoE IP Camera with Extended Support
ICA-E5550V	5 Mega-pixel Vandalproof IR PoE IP Camera with Extended Support
ICA-E6260	2 Mega-pixel PoE Plus Speed Dome IP Camera with Extended Support
ICA-M3380P	H.265 3 Mega-pixel Bullet IR IP Camera with Remote Focus and Zoom
ICA-M5380P	H.265 3 Mega-pixel Vandalproof IR IP Camera with Remote Focus and Zoom
ICA-2250VT	Industrial PoE Plus Outdoor IR IP Camera
ICA-3250	1080p IR Bullet PoE IP Camera
ICA-4250	1080p IR Dome PoE IP Camera
ICA-W3250V	Full HD Outdoor IR Wireless IP Camera
ICA-HM620	2 Mega-pixel PoE Plus Speed Dome Internet Camera
WNAP-7350	5GHz 300Mbps 802.11a/n Outdoor Wireless Access Point (2 x N-type Connector)
WNAP-6350	2.4GHz 300Mbps 802.11n Outdoor Wireless Access Point (2 x N-type Connector)
IGT-1205AT	Industrial 10/100/1000T to 2-port 100/1000X SFP Media Converter
IGT-805AT	Industrial 10/100/1000BASE-T to 100/1000BASE-X SFP Media Converter (-40~75 degrees C)