

4MP WDR Vandal-resistant Network IR Fixed Dome Camera

IPC324ER3-DVPF28(36)(60)



Key Features

Optics

- Day/night functionality
- Smart IR, up to 30 m (98 ft) IR distance
- Up to 120 dB WDR (Wide Dynamic Range)
- 2D/3D DNR (Digital Noise Reduction)

Compression

- Ultra 265, H.264, MJPEG
- Embedded smart algorithm
- ROI (Region of Interest)
- Customized OSD

Network

- ONVIF Conformance

Structure

- Wide temperature range: -35°C to 60°C (-31°F to 140°F)
- Wide input voltage range of $\pm 25\%$
- IK10 vandal resistant

- IP67
- 3-Axis

Specifications

	IPC324ER3-DVPF28	IPC324ER3-DVPF36			IPC324ER3-DVPF60
Camera					
Sensor	1/3", progressive scan, 4.0 megapixel, CMOS				
Lens	2.8mm@F2.0		3.6mm@F2.0		6.0mm@F2.0
DORI Distance	Lens	Detect(m)	Observe(m)	Recognize(m)	Identify(m)
	2.8mm	63	25.2	12.6	6.3
	3.6mm	81	32.4	16.2	8.1
	6 mm	135	54	27	13.5
Angle of View (H)	104.4°		86.4°		49.9°
Angle of View (V)	67°		53.2°		32.9°
Angle of View (O)	135.7°		112.3°		61.4°
Adjustment angle	Pan: 0°~360°		Tilt: 0°~75°		Rotate: 0°~360°
Shutter	Auto/Manual, 1~1/100000 s				
Minimum Illumination	Colour: 0.02 Lux (F2.0, AGC ON) 0 Lux with IR				
Day/Night	IR-cut filter with auto switch (ICR)				
Digital noise reduction	2D/3D DNR				
S/N	>55 dB				
IR Range	Up to 30m (98 ft) IR range				
Defog	Digital Defog				
WDR	120dB				
Video					
Video Compression	Ultra 265, H.264, MJPEG				
H.264 code profile	Baseline profile, Main Profile, High Profile				
Frame Rate	Main Stream:4MP (2592×1520): Max. 20 fps, 4MP (2560×1440): Max. 25 fps, 3MP (2048×1520): Max. 30 fps; Sub Stream:2MP (1920×1080): Max. 30 fps; Third Stream:D1(720×576) : Max. 30fps				
HLC	Supported				
BLC	Supported				
9:16 Corridor Mode	Supported				
OSD	Up to 8 OSDs				
Privacy Mask	Up to 8 areas				
ROI	Up to 8 areas				
Motion Detection	Up to 4 areas				
Smart					
Behavior Detection	Intrusion, cross line, motion detection				
Intrusion	Enter and loiter in a pre-defined virtual region				
cross line	Cross a pre-defined virtual line				

motion detection	Moving within a pre-defined virtual region
Recognition:	Face detection、 Audio detection
Intelligent Identification	Defocus, Scene Change, Object Left, Object Moving
Statistical Analysis	People counting
General Function	Watermark, IP Address Filtering, Tampering Alarm, Alarm input, Alarm output, Access Policy, ARP Protection, RTSP Authentication, User Authentication
Audio	
Audio Compression	G.711
Two-way audio	Supported
Suppression	Supported
Sampling Rate	8 KHZ
Storage	
Edge Storage	Micro SD, up to 128 GB
Network Storage	ANR
Network	
Protocols	IPv4, IGMP, ICMP, ARP, TCP, UDP, DHCP, PPPoE, RTP, RTSP, RTCP, DNS, DDNS, NTP, FTP, UPnP, HTTP, HTTPS, SMTP, 802.1x, SNMP
Compatible Integration	ONVIF(Profile S, Profile G), API
Interface	
Audio I/O	Input: impedance 35 kΩ; amplitude 2 V [p-p]
	Output: impedance 600 Ω; amplitude 2 V [p-p]
Alarm I/O	1/ 1
Network	1 RJ45 10M/100M Base-TX Ethernet
General	
Power	12 V DC±25%, PoE (IEEE802.3 af)
	Power consumption: Max 5W
Dimensions (∅ x H)	∅108.5 x 81 mm (∅4.28" x 3.2")
Weight	0.45 kg (0.99 lb)
Working Environment	-35°C ~ +60°C (-31°F ~ 140°F), Humidity:10%~95% RH(non-condensing)
Ingress Protection	IP67
Vandal Resistant	IK10

Dimensions

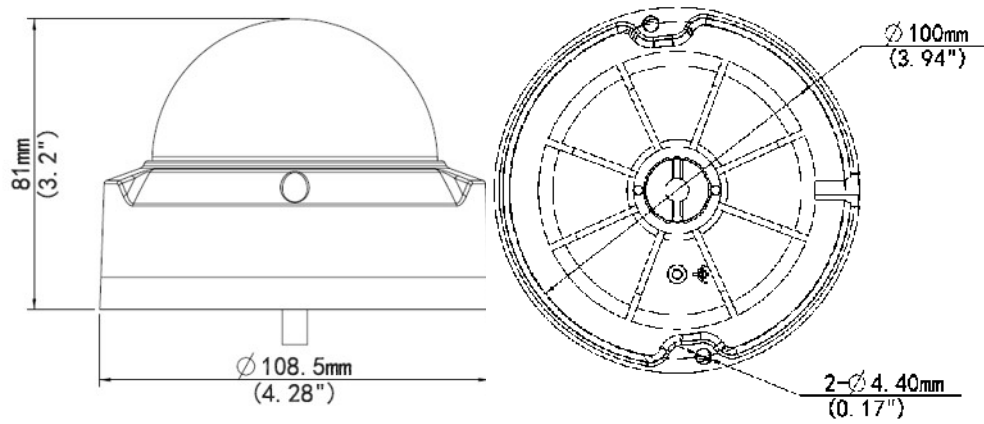
**Zhejiang Uniview Technologies Co., Ltd.**

South Tower, Building 10, Wanlun Science Park, 88 Jiangling Road, Hangzhou, P.R.China 310051

Email: overseasbusiness@uniview.com; globalsupport@uniview.com

<http://www.uniview.com>

©2016-2018 Zhejiang Uniview Technologies Co., Ltd. All rights reserved.

*Product specifications and availability are subject to change without notice.