



S series **FE9181-H**
S series **FE9381-EHV**
Fisheye Network Camera



H.265 · 5MP · 360° Surround View · Smart Stream II · WDR Pro · 3DNR · IP66 · IK10 · EN50155 Compliance · Pixel Counter · Defog

VIVOTEK's FE9181-H and FE9381-EHV are two unique H.265 fisheye fixed dome network cameras, both featuring a detailed 5-Megapixel CMOS sensor that produces superb image clarity. By employing H.265 compression technology and VIVOTEK's Smart Stream II technology, these cameras can reduce both bandwidth and storage consumption by up to 80%* while retaining the highest standard of image quality.

Equipped with a fisheye lens for 180° panoramic view (wall mount) or 360° surround view (ceiling/floor mount) with zero blind spots, the cameras are able to provide coverage of wide, open areas, such as airports, shopping malls, retail stores, offices and more.

The FE9181-H and the FE9381-EHV are both equipped with a removable IR-cut filter and WDR Pro technology, empowering the cameras to maintain optimal image quality around the clock and unparalleled visibility in high-contrast lighting environments. Moreover, the FE9381-EHV is designed with full EN50155 compliance, vandal-proof IK10-rated, and weather-proof IP66-rated housing, ensuring that the camera can withstand shock, vibration, humidity, dust, and temperature fluctuations, and maintain stable and reliable video capture during vehicle movement.

* Depending on scene being monitored.

Key Features

- H.265 Compression Technology
- 5-Megapixel CMOS Sensor
- 30 fps @ 1920x1920
- 1.47 mm Fisheye Lens for 180° Panoramic View and 360° Surround View
- Removable IR-cut Filter for Day & Night Function
- WDR Pro for Unparalleled Visibility in High Contrast Environments
- Smart Stream II to Optimize Bandwidth Efficiency
- EN50155 Compliance for Professional Mobile Surveillance (FE9381-EHV)
- Vandal-proof IK10-rated and Weather-proof IP66-rated Housing (FE9381-EHV)
- ePTZ for Data Efficiency
- Built-in 802.3af Compliant PoE
- Support Client Side Dewarping
- Pixel Counter for Image Clarity Measurement

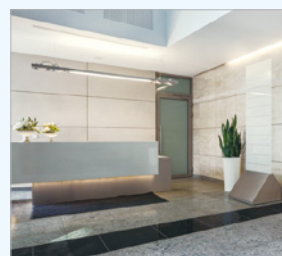
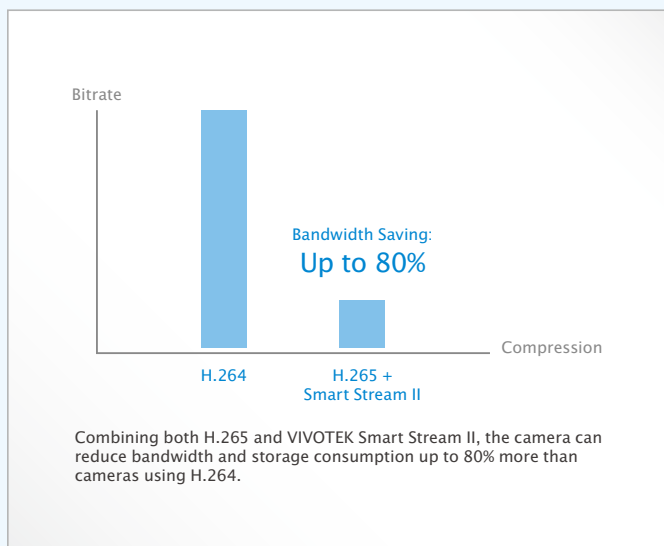

Lobby



Shopping Mall



Retail



Airport

Technical Specifications

Model	FE9181-H: WDR Pro FE9381-EHV: WDR Pro, IP66, IK10, EN50155, Extreme Weather
System Information	
CPU	Multimedia SoC (System-on-Chip)
Flash	128MB
RAM	512MB
Camera Features	
Image Sensor	1/1.8" Progressive CMOS in 3096x2094
Maximum Resolution	1920x1920
Lens Type	Fixed-focal
Focal Length	f = 1.47 mm
Aperture	F2.2
Field of View	180° (Horizontal) 180° (Vertical) 180° (Diagonal)
Shutter Time	1/5 sec. to 1/32,000 sec.
WDR Technology	WDR Pro
Day/Night	Removable IR-cut filter for day & night function
Minimum Illumination	0.18 Lux @ F2.2 (Color) 0.001 Lux @ F2.2 (B/W)
Pan/Tilt/Zoom Functionalities	ePTZ: 48x digital zoom (4x on IE plug-in, 12x built-in)
On-board Storage	Slot type: MicroSD/SDHC/SDXC card slot Seamless Recording
Video	
Compression	H.265, H.264, MJPEG
Maximum Frame Rate	H.265 & H.264: 30 fps @ 1920x1920 MJPEG: 12 fps @ 1920x1920
Maximum Streams	4 simultaneous streams
S/N Ratio	42.3 dB
Dynamic Range	100 dB
Video Streaming	Adjustable resolution, quality and bitrate Smart Stream II
Image Settings	Time stamp, text overlay, flip & mirror; Configurable brightness, contrast, saturation, sharpness, white balance, exposure control, gain, backlight compensation, privacy masks; Scheduled profile settings, 3D noise reduction; Adjustable image size, quality and bit rate, defog; Pixel counter
Audio	
Audio Capability	Two-way audio (full duplex)
Compression	G.711, G.726
Interface	Built-in microphone External microphone input External line output
Effective Range	5 meters
Network	
Users	Live viewing for up to 10 clients
Protocols	IPv4, IPv6, TCP/IP, HTTP, HTTPS, UPnP, RTSP/RTP/RTCP, IGMP, SMTP, FTP, DHCP, NTP, DNS, DDNS, PPPoE, CoS, QoS, SNMP, 802.1X, UDP, ICMP, ARP, SSL, TLS, NTCIP, CIFS/SMB
Interface	10 Base-T/100 BaseTX Ethernet (RJ-45) *It is highly recommended to use standard CAT5e & CAT6 cables which are compliant with the 3P/ETL standard.
ONVIF	Supported, specification available at www.onvif.org
Intelligent Video	
Video Motion Detection	Five-window video motion detection

Alarm and Event

Alarm Triggers	Motion detection, manual trigger, digital input, periodical trigger, system boot, recording notification, camera tampering detection, audio detection
Alarm Events	Event notification using digital output, HTTP, SMTP, FTP, NAS server and MicroSD Card File upload via HTTP, SMTP, FTP, NAS server and MicroSD Card

General

Connectors	RJ-45 cable connector for Network/PoE connection Audio input*1 Audio output*1 DC 12V power input*1 Digital input*1 Digital output*1
LED Indicator	System power and status indicator
Power Input	DC 12V IEEE 802.3af PoE Class 0
Power Consumption	FE9181-H: Max. 5.5 W FE9381-EHV: Max. 13 W
Dimensions	FE9181-H: Ø 139 x 38 mm FE9381-EHV: Ø 145 x 50 mm
Weight	FE9181-H: 345 g FE9381-EHV: 548 g
Casing	FE9381-EHV: Weather-proof IP66-rated housing Vandal-proof IK10-rated metal housing
Safety Certifications	CE, LVD, FCC Class A, VCCI, C-Tick, UL, EN50155 (FE9381-EHV)
Operating Temperature	FE9181-H: Starting Temperature: 0°C ~ 50°C (32°F ~ 122°F) Working Temperature: -10°C ~ 50°C (14°F ~ 122°F) FE9381-EHV: Starting Temperature: -25°C ~ 55°C (-13°F ~ 131°F) Working Temperature: -40°C ~ 55°C (-40°F ~ 131°F)
Humidity	90%
Warranty	36 months

System Requirements

Operating System	Microsoft Windows 7/8
Web Browser	Mozilla Firefox 7~10 (Streaming only) Internet Explorer 10/11
Other Players	VLC: 1.1.11 or above Quicktime: 7 or above

Included Accessories

CD	User's manual, quick installation guide, Shepherd, VAST
Others	Quick installation guide, warranty card, alignment sticker, desiccant bag, screw driver, screws pack, I/O cable, mounting bracket, software CD

Dimensions

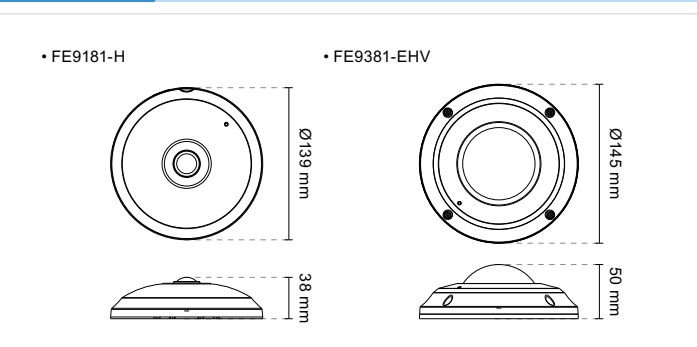

Compatible Accessories

Mounting Kits



AM-514
Adapter Ring for
FE9181-H



AM-520
Mounting Adapter