

BRX

MICRO DVR



USER GUIDE

Models: BRX2004A & BRX2008A

VER 2.1.0

- *Thank you for purchasing the BRX Micro DVR from D-TEG.*
- *Please ensure that you read and understand this USER GUIDE and use it before connecting and installing this Recorder.*
- *Please store the USER GUIDE in an easily accessible location.*

D-TEG

SAFETY ADVICE



CAUTION

RISK OF ELECTRIC SHOCK
DO NOT OPEN



CAUTION: TO REDUCE THE RISK OF ELECTRIC SHOCK,
DO NOT REMOVE COVER.
NO USER-SERVICEABLE PARTS INSIDE.
REFER SERVICING TO QUALIFIED SERVICE PERSONNEL.

Please make sure you follow the safety advice/instructions given in the user guide.

CAUTION

**RISK OF EXPLOSION IF BATTERY IS REPLACED BY AN INCORRECT TYPE.
DISPOSE OF USED BATTERIES ACCORDING TO THE INSTRUCTIONS.**

Battery for RTC(Real Time Clock) inside

CAUTION

Connect your vehicle's power cable to the product after starting the vehicle.

The instant over voltage generated when starting up the vehicle may damage the product if it is already connected.

CAUTION

Install the product where it does not block driver's visibility and where there is no airbag installed. This could cause an accident or might injure the passengers in case of accident.

CAUTION

Damages due to production malfunction, loss of data, or other damages occurring while using this product shall not be the responsibility of the manufacturer. Although the product is a device used for recording videos, the product may not save all videos in the case of a malfunction. In the case of an accident, the sensor may not recognize the shock when the impact is light and as a result it may not begin recording automatically.

WARNING:

**TO PREVENT FIRE OR ELECTRIC SHOCK HAZARD,
DO NOT EXPOSE THIS APPLIANCE TO RAIN OR MOISTURE.**

GPS Reception

- 1. Activate the product in an area without large buildings to improve GPS reception.**
The commercial purpose GPS has the average range error of more than 15 meters and the range error could be more than 100 meters due to environmental conditions like buildings, roadside trees etc.
- 2. The temperature range for optimum operation of the GPS receiver in your car is -10 ~ 50°C.**
- 3. When using the product for the first time or after a long period (more than three days), it may take a little longer to recognize your current location.**
It may take between five and thirty minutes to get GPS reception.

GPS reception may be impaired under the following circumstances.

- 1) If there is an object at the end of the GPS antenna
- 2) If your vehicle has metallic elements on the windshields
- 3) If equipment generating electromagnetic waves that interfere with the GPS signal is installed in the vehicle e.g.: Other GPS devices such as a certain type of wireless activated alarms, MP3 and CD players and camera alarms using GPS.
- 4) If you are using a receiver connected by cable, electric interference can be avoided by simply changing the location of the receiver (antenna).
- 5) On heavily overcast or cloudy days, if the vehicle is in a covered location such as under a bridge or raised roadway, in a tunnel, an underground roadway or parking area, inside a building or surrounded by high-rise buildings.
- 6) If GPS signal reception is poor, it may take longer to locate your current position when the vehicle is moving than when it is stationary.

CONTENTS

Each BRX2004A/2008A order includes the following items.

1. Main unit



2. GPS module with waterproof case



3. Camera input cable



4. Power cable



5. Car signal cable



6. Alarm IN/OUT, Video In/Out cable



7. Mini USB Cable



8. USER GUIDE



9. DVR Viewer CD

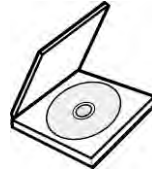

10. Keys, Screws



11. Mount/ Rear Bracket



INTRODUCTION

FRONT

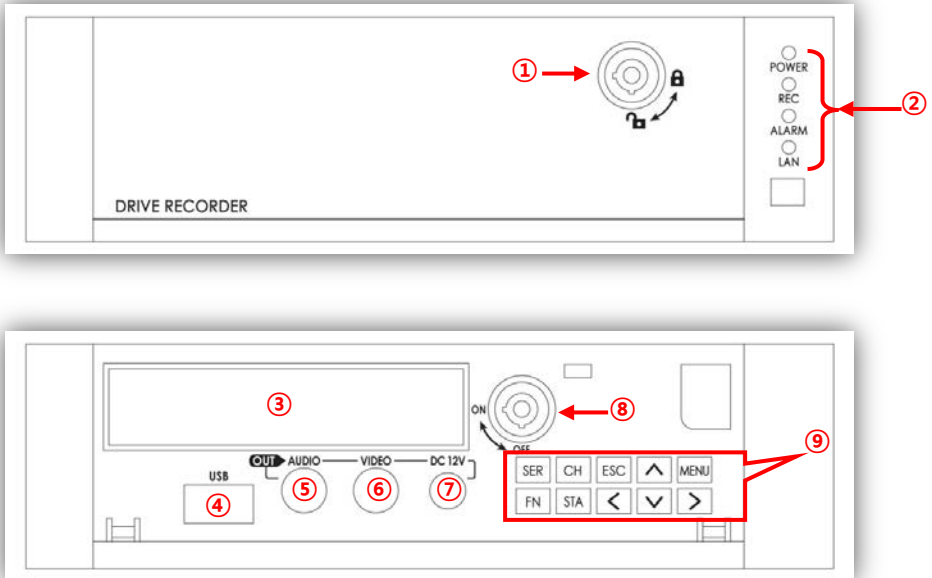

- ① System Door Lock
- ② LED
 - [POWER] : Green LED indicates power-on
 - [REC] : Yellow LED indicates record-on
 - [ALARM] : Red LED indicates Video loss or SSD/HDD failure.
 - [LAN] : Yellow LED indicates network-on
- ③ Removable HDD/SSD: Removable lock should be unlocked and Power/REC LED should be off in order to remove the HDD/SSD.
- ④ USB port: Ready for firmware upgrade & Upload / Download of configuration file (set operation condition).
- ⑤ Audio Out port
- ⑥ Video Out Port
- ⑦ DC 12V power Out Port : Ready for portable monitor or other electronic devices
- ⑧ Removable HDD/SSD Lock;
 - . Off → On: Turn on BRX and booting is completed in 42 seconds.
 - . On → Off: Turn off BRX. BRX is shut down in 15 seconds.

INTRODUCTION

FRONT

⑨ BUTTON

[SER] : Searches the recorded data.

[CH] : Changes the camera on display.

(Camera 1 → Camera 2 → Camera 3 ->.... ->Camera 8 → Camera 1)

[ESC] : Cancels or exits from the selected modes or menus.

[MENU] Enters into the menu.

[FN] : Funtion Key: used in combination with other buttons as follows;

FN + UP: Uploads the configuration file (operation settings, saved from the DVR Viewer software through the USB memory stick.

FN + DOWN: Downloads the configuration file (operation settings) of the current BRX to USB memory stick.

[STA] : Displays current status of BRX DVR operation.

INFORMATION: shows firmware version, GPS acceptance, Car Signal, G-Sensor)

[Arrow/ Direction]: Moves the highlight between items in the setting menu.

Change the live display layout: Left arrow(8 channels), Right arrow(4 channels)

[Time Delay Function]

In case of Power On /Off by ACC signal in vehicle;

Time delayed start

Off → On : Starts BRX 5 seconds later and booting is completed in 47 seconds.

Time delayed shutdown

On → Off : Stops recording immediately (record LED off) and shutdown takes 75 seconds till completed (power LED off)

INTRODUCTION

REAR

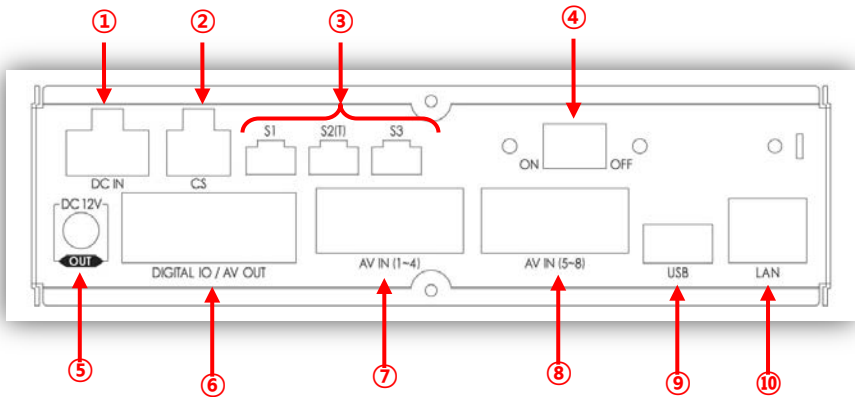

- ① Power Connector
Battery : Connects to the battery power in vehicle.
ACC : Connects to the ignition power in vehicle.
- ② Car Signal Connector: left/right signals, brake, reverse, speed pulse signal
- ③ Serial Port
S1 : For trouble shooting (debugging) purpose
S2(T) : Ready for interface to additional device
S3 : Connect the provided GPS
- ④ Main power Switch
- ⑤ Power out: Ready for portable monitor or other device (DC 12V OUT)
- ⑥ DIGITAL IO / AV OUT
Alarm in; 8 ports
Alarm Out: 2 ports
Video / Audio Out
- ⑦ AV In (1~4)
For camera 1 ~ 4 (Video, Audio signal & power supply to camera (12V)
- ⑧ AV In (5~8)
For camera 5 ~ 8 (Video, Audio signal & power supply to camera (12V)
- ⑨ USB: firmware upgrade & Upload / Download of configuration file (set operation condition).
- ⑩ LAN

CONNECTION DIAGRAM

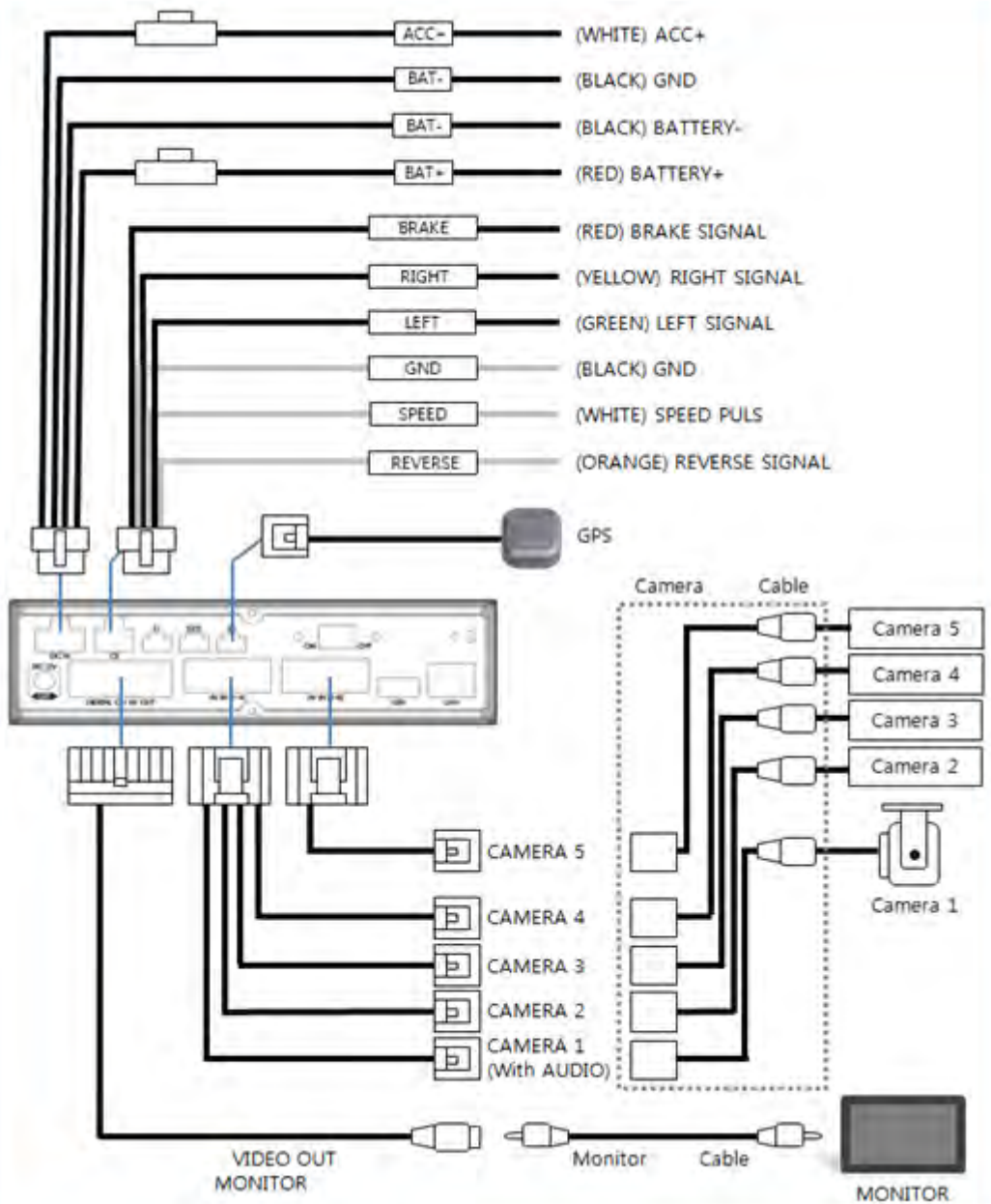

POWER ON

1. TURNING ON THE POWER

- ① Make sure that peripherals are properly connected.
- ② Switch「ON」the main power switch on the rear panel as below,

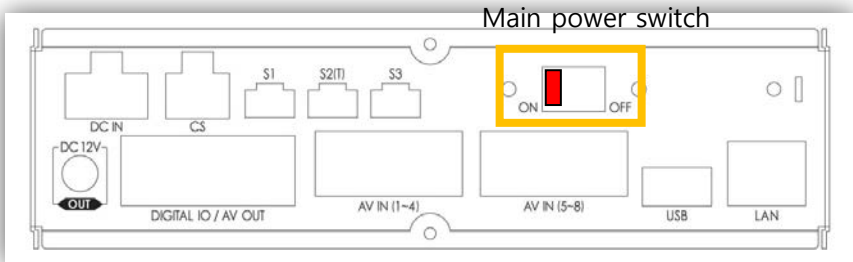

- ③ Turn on the Removable HDD/SSD lock using key from [OFF] to [ON] as below,

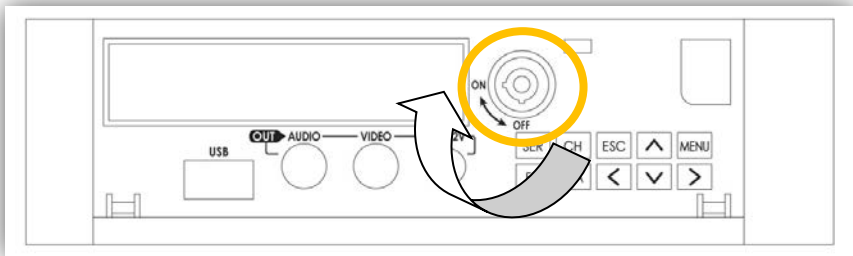

The front POWER LED will light up in green. Please wait approximately 42 seconds until it start recording up. The recording will automatically begin just power on.



POWER OFF

2. TURNING OFF THE POWER

- ① Turn off the Removable HDD/SSD lock using key from [ON] to [OFF] as below,

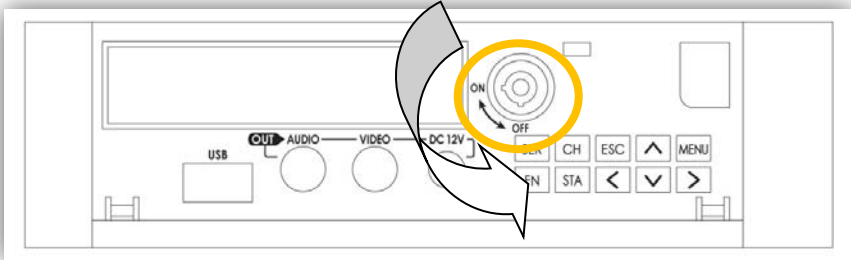

The RECORD LED will be off immediately and the front POWER LED will be off in 15 seconds.



[System shutdown pop-up window]

- ② Power LED should be off in order to remove the Removable HDD/SSD from the DVR.

SYSTEM OPERATION

LIVE DISPLAY

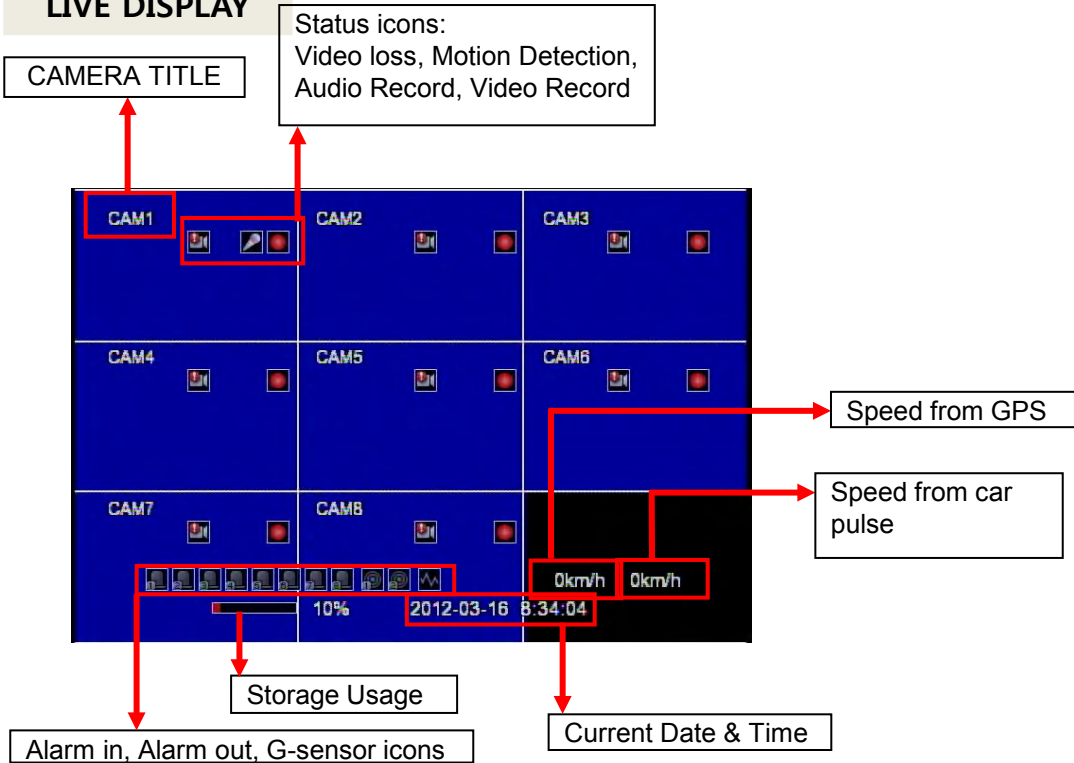

Press [CH] button to see a single channel display

Press [Right] button to see 4 channel display

Press [Left] button to see 8 channel display

Default display layout can be set in Device menu of the DVR Viewer.

NOTE – To change default display

Run DVR Viewer => Setting => Machine Config [New] or [OPEN] => Select Model BRX2008A or BRX2004A => Device => Default Layout

Live display priority can be set in Event menu of the DVR Viewer.

NOTE – To change live display priority

Run DVR Viewer => Setting => Machine Config [New] or [OPEN] => Select Model BRX2008A or BRX2004A => Event => Liveout Priority

SYSTEM OPERATION

LIVE DISPLAY ICONS



Video Loss, No Camera



Motion Detection



Audio Record



Continuous Record (RED)



Event Record (YELLOW)



Detect Alarm in 1



Detect Alarm in 2



Detect Alarm in 3



Detect Alarm in 4



Detect Alarm in 5



Detect Alarm in 6



Detect Alarm in 7



Detect Alarm in 8



Activate Alarm out 1



Activate Alarm out 2



Detect G-sensor Event

STATUS

To turn off/on the status icons, Press the [STA] button.
Below are the different views you can toggle with the [STA] button,



1. [All Icons]



2. [Without Icons]

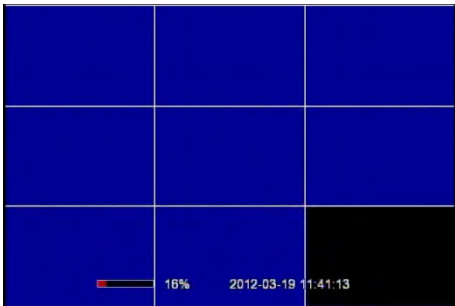

3. [Without Icons, Camera titles]

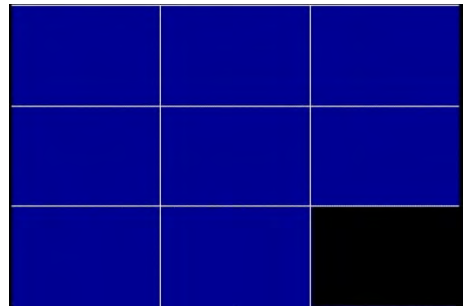

4. [Without all icons]

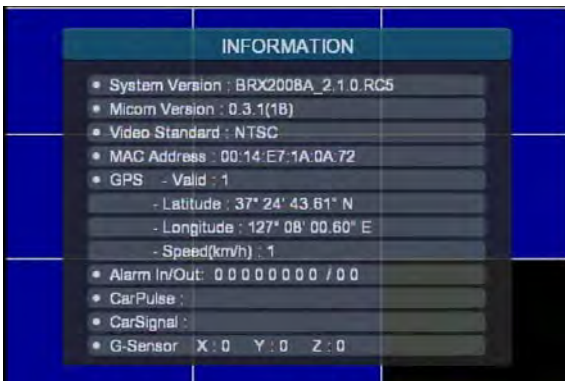

5. [Information]

This information page shows the current system information such as firmware version, GPS acceptance, Alarm In/Out, Car Speed Pulse Type, Car Signal and G-Sensor.

MAIN MENU

Press the [MENU] button on the front panel brings up the main menu below.



The on-screen menus allow you to check the configuration. Only some settings can be changed here, please use provided DVR Viewer PC Software to set up all the features of BRX.

All setup data is safe from power loss and stored in the internal flash memory of DVR.

1. SELECTING A MENU ITEM

Press the MENU Button to select a menu item.

If you press the ESC button, it returns to the previous menu.

2. POSITIONING THE YELLOW COLOR HIGHLIGHT

Use the up and down arrow buttons to position the yellow selector.

Press the left and right buttons to move to the next value in the selected menu.

3. SETTING AN OPTION

Press the left and right buttons to see additional options (only if you see the < and > marks).

Press the up and down buttons if there are no marks.

MAIN MENU

CAMERA

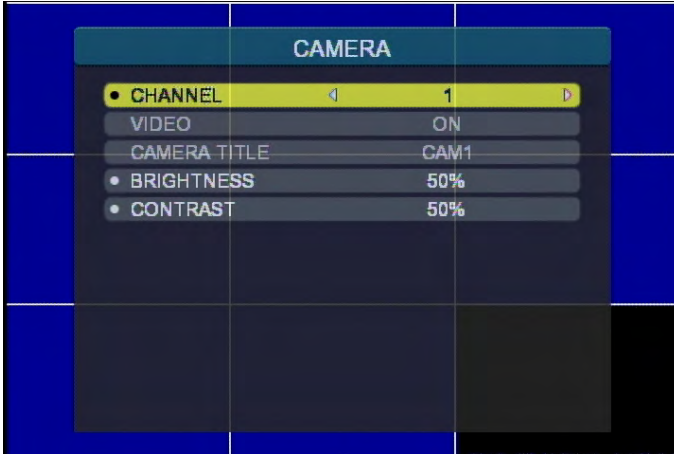

Brightness and Contrast of each channel can be configured in this menu.
To change the Video or Camera title, please use the DVR Viewer on your PC.

Press [ESC] button to return to the previous mode.

SIGNAL

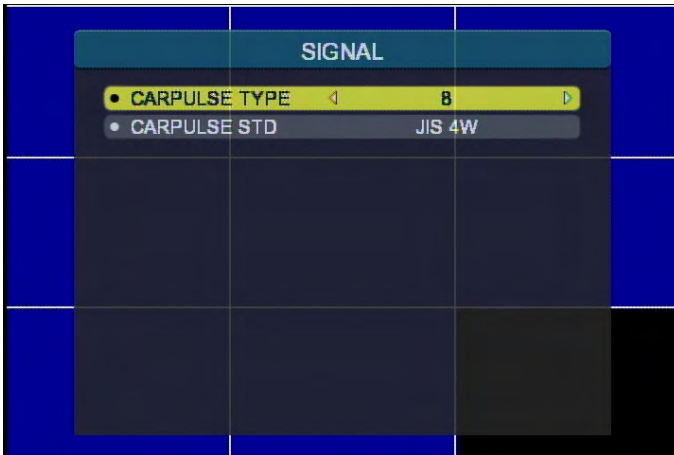

Speed pulse type and pulse standard can be configured in this menu.
Press [ESC] button to return to the previous mode.

MAIN MENU

G-SENSOR



G-sensor calibration can be configured in this menu.

G-SENSOR(X) 0, 90, 180, 270

- (Y) 0, 90, 180, 270

- (Z) 0, 90, 180, 270

[Example- Standard Installation]

FRONT (X axis): Front sides of BRX and car must be in line, facing the front side.

LEFT (Y axis): Left side of BRX must be facing the left side of car and BRX must be horizontal, parallel with the ground.

TOP (Z axis): Top of BRX must be vertical to ground.

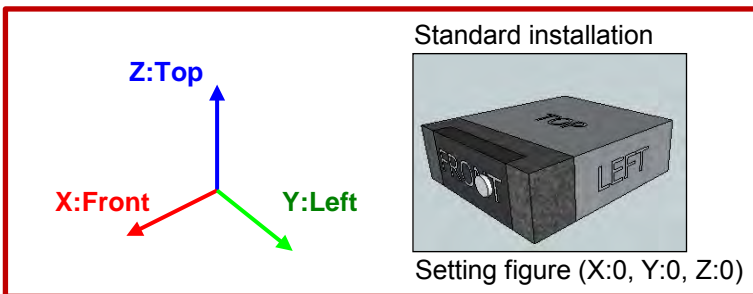

For more details, please refer to page 28.

G-sensor sensitivity level can be configured in this menu.

Sensitivity level 1 is dull, level 5 is very sensitive.

Press [ESC] button for returning to the previous mode.

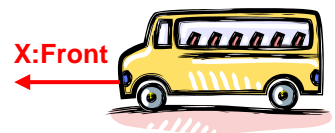

MAIN MENU

DISPLAY



This menu is to view/change the default display screen.
To change which screen is your default display screen, please use the DVR Viewer on your PC.
Press [ESC] button for returning to the previous mode.

RECORD



Recording conditions such as Frame Rate, Resolution and Image Quality can be changed.
To change the Record set up, please use the DVR Viewer on your PC.

MAIN MENU



To change the Resolution, Quality, Pre-recording time, Post-recording time, please use the DVR Viewer on your PC.



Change the channel and check the record set up per channel
To change the Record Normal/Event, fps, audio on/off, please use the DVR Viewer on your PC.



Disk End Mode (Overwrite) ON/OFF. If "ON" the BRX will overview the oldest video when the HDD/SDD becomes full. "OFF" setting will notify you when HDD/SDD is full. To change the Disk End mode, please use the DVR Viewer on your PC.
Press [ESC] button for returning to the previous mode.

MAIN MENU

SYSTEM

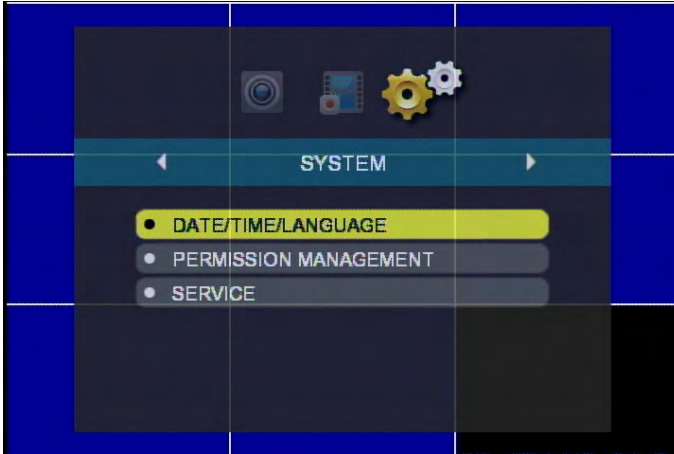

DATE/TIME/LANGUAGE and NTSC/PAL can be configured in this menu.

Press [ESC] button for returning to the previous mode.

DATE/TIME/LANGUAGE

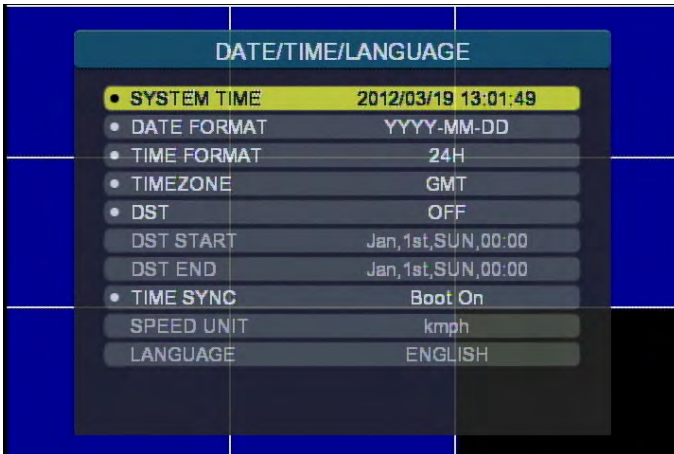

System time, Date format, Time format, Time zone, DST, GPS Time Synchronize can be configured in this menu.

MAIN MENU

PERMISSION MANAGEMENT



DVR ID, USER ID can be changed here. To change the DVR ID, USER ID, please use the DVR Viewer on your PC.

DATE/TIME/LANGUAGE

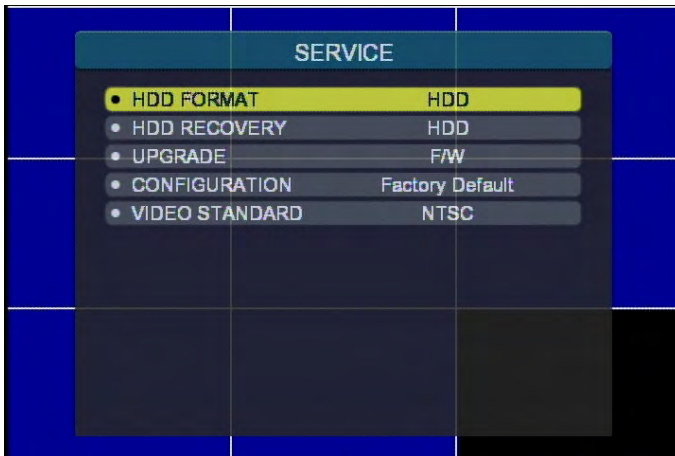

HDD Format, HDD recovery, Firmware upgrade, Factory Default can be done.

Video standard (NTSC/PAL) can be set here.

HDD Format time differs from the capacity of SSD/HDD. Be carefully noted that HDD Format deletes all the current data.

Power cut-off during HDD FORMAT or UPGRADE can cause serious damage to the system. Please make it sure that the power is safely supplied.

CONFIGURATION SETTINGS

UPLOADING YOUR SETTINGS TO THE BRX

The configuration file can be saved into a USB memory stick via DVR Viewer Software.

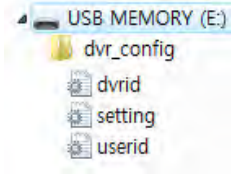

Insert USB memory stick containing the configuration file (set operation condition) to USB port in BRX.

It may take around 5~10 seconds until the USB stick is recognized.

Then press and hold the [Fn] button & press [Up] Button.

Upload of configuration file will then start and a beep will sound 3 times, for 3 seconds.

When Upload is finished, [REC] LED will turn on and recording will start automatically.

USB memory stick can then be removed.

DOWNLOADING YOUR SETTINGS FROM THE BRX

Insert USB memory stick containing the configuration file (set operation condition) to USB port in BRX.

It may take around 5~10 seconds until the USB stick is recognized.

Then press and hold the [Fn] button & press [Down] Button.

The configuration file download will then start automatically and a beep will sound twice.

It takes 1 second. USB memory stick can be then removed.

BRX200A DVR Viewer Guide

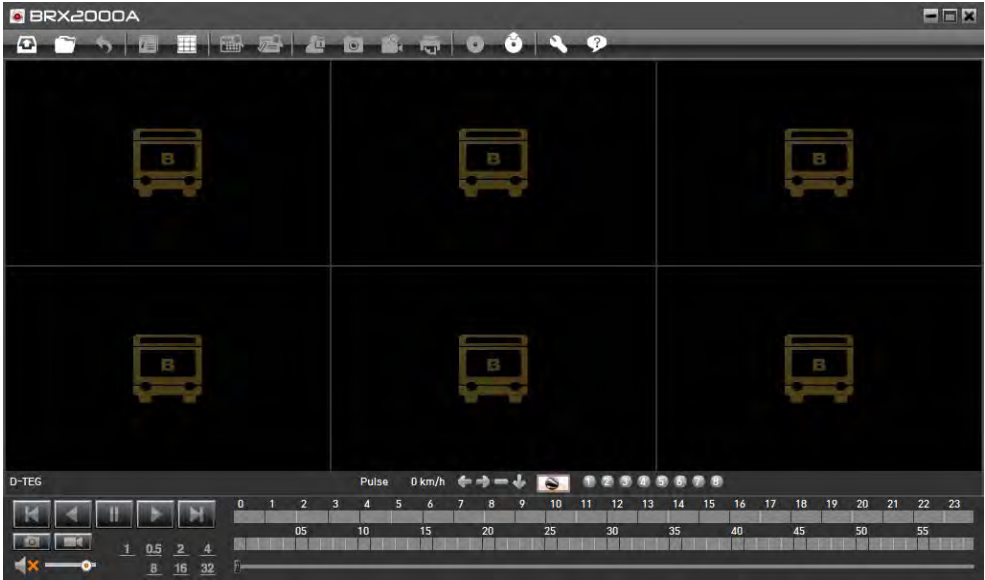

[PC SYSTEM REQUIREMENT]

Recommended PC specifications for DVR Viewer software

OS	Windows XP, Windows Vista, Windows 7
CPU	Intel Core 2 Duo (2Ghz)or higher
RAM	1GB or higher
VGA Memory	256MB or higher
HDD Free space	120MB or higher
Display	1,024 x 768 pixel/High Color(16bit) or higher
External Device	Removable HDD (File System:Ext3) Need to install Ext2Fsd Driver

If the PC does not meet the minimum system requirement, the DVR Viewer may not function properly.

INSTALLING PROCEDURES

DVR Viewer software is on the provided CD.

1. Insert the CD into your PC and run [SETUP.EXE].
2. Select the language and then follow the dialog box.

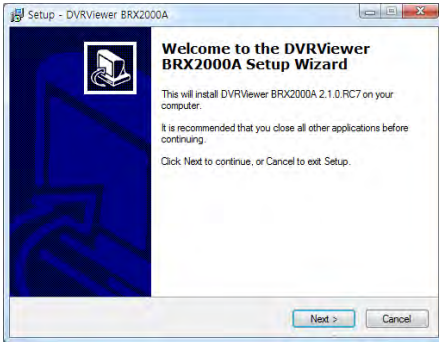

3. Continuously install Ext2Fsd driver. It's necessary to read the removable HDD/SSD.



4. Click Finish to allow the system to reboot. This completes the installation.

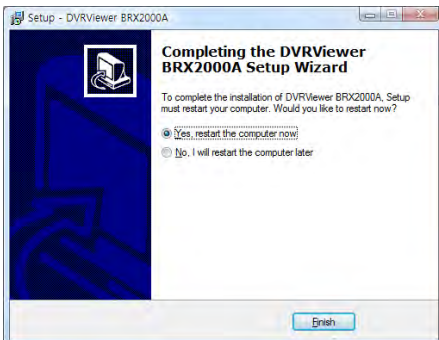

PC SOFTWARE & DVR VIEWER SETTINGS

The “DVR Viewer” icon will be displayed on your desktop. Click to run DVR viewer.



※ NOTE: To Un-install the “DVR Viewer BRX2004A”

Open the “Control Panel”

Select [Remove Program] and remove [DVR Viewer BRX2004A]

To set the DVR Viewer itself, Click the setting icon.



setting

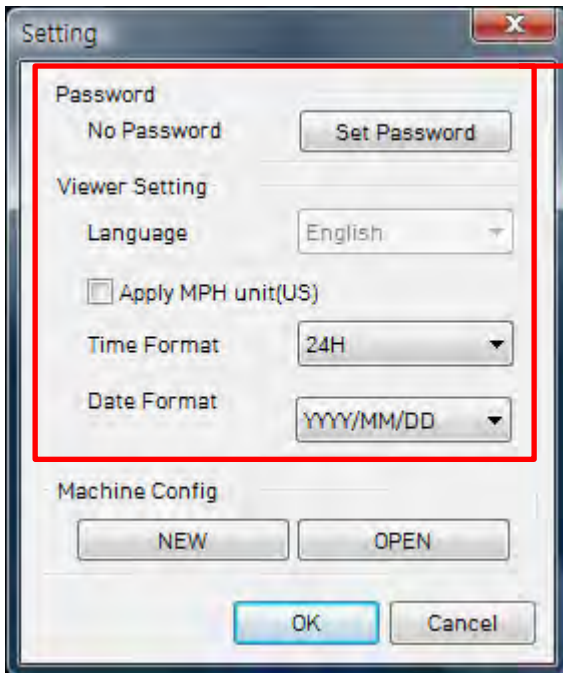

This setting is for
DVR Viewer itself.

Set the DVR Viewer
Password.
[This password is for
DVR viewer itself.
This is different from
your DVR password or
stream password.]

It can change speed
unit from Km/h to mph.

Also can select Time
and Date format of
DVR Viewer.

DVR CONFIGURATION: SETTING FILE

To set the DVR configuration,
First, connect a USB memory stick into your PC's USB slot.
Run "DVR Viewer BRX2000A" Software and click the setting icon.



setting

And then click Machine config [NEW]



Select your DVR model first, and then click OK.

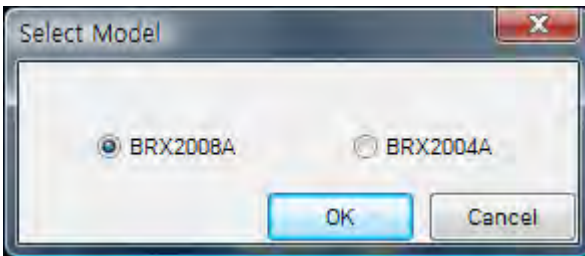

If you already have a DVR configuration in your memory stick, click [OPEN].

Select "setting" file from your memory stick.
"setting" file is in the dvr_config folder as below,

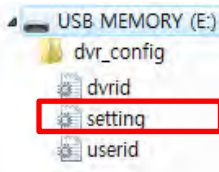

→ "Setting" file

DVR CONFIGURATION: DEVICES

DEVICE

Camera ON/OFF

Select the cameras to connect.

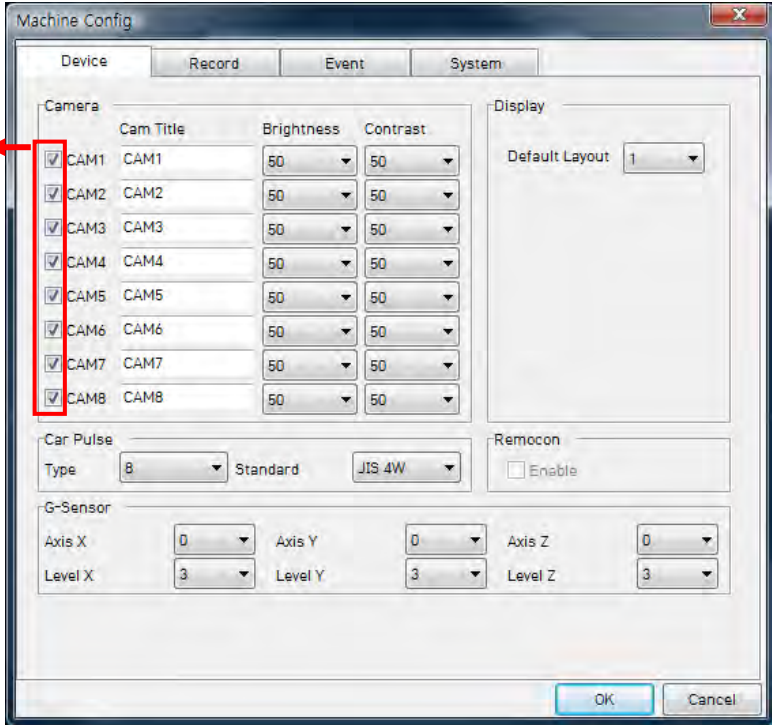

Camera	Cam Title	The camera title can be up to 10 characters.
	Brightness	Adjust Brightness of camera
	Contrast	Adjust Contrast of camera
Display	Default layout	Select default display layout. If you set 2x2, when you turn on the DVR quad screen will be displayed.
Car Pulse	Type	Select your speed pulse type
	Standard	Select your speed pulse standard

Before using “ Car Pulse Type”, connect the Speed pulse cable to the speed pulse line on your car. Please consult your car manufacturer or a car repair shop regarding this connection.

DVR CONFIGURATION: G-SENSOR CALIBRATION

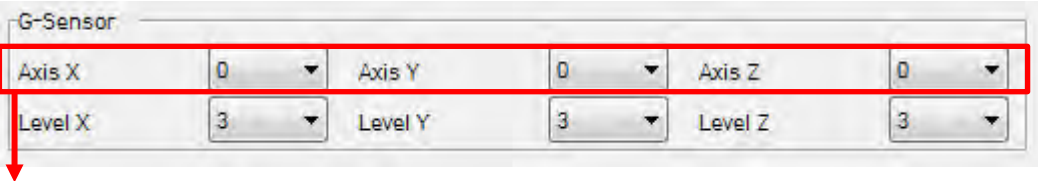

G-Sensor Calibration

If you install

FRONT (X axis): Front sides of BRX and car must be in line, facing the front side.

LEFT (Y axis): Left side of BRX must be facing the left side of car and BRX must be horizontal, parallel with the ground.

TOP (Z axis): Top of BRX must be vertical to ground

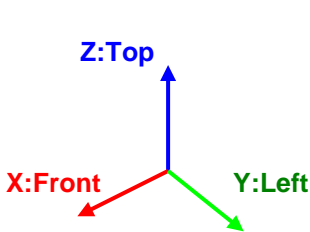

Standard installation

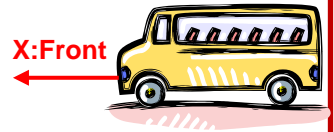
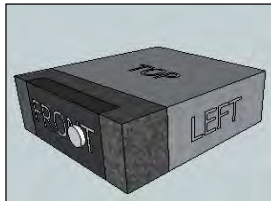

Setting figure (X:0, Y:0, Z:0)

Different installation 1 - BRX top is facing the ceiling.

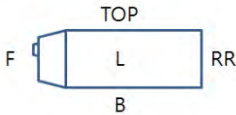

(X:0, Y:0, Z:0)

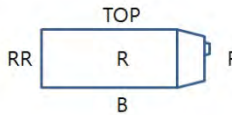

(X:0, Y:0, Z:180)

F : Front	RR : Rear
TOP : Top	B : Bottom
R : Right	L : Left

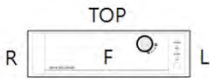

(X:0, Y:0, Z:270)

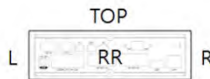

(X:0, Y:0, Z:90)

DVR CONFIGURATION: CALIBRATION OPTIONS

Different installation 2 - BRX top is facing the ground.

F : Front	RR : Rear
TOP : Top	B : Bottom
R : Right	L : Left



(X:180, Y:0, Z:0)

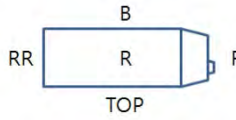

(X:180, Y:0, Z:180)

(X:180, Y:0, Z:270)

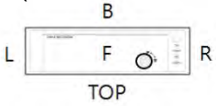

(X:180, Y:0, Z:90)



Different installation 3

- BRX front is facing left side of the car.



(X:270, Y:0, Z:0)



(X:270, Y:180, Z:0)

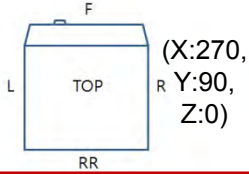

(X:270, Y:90, Z:0)

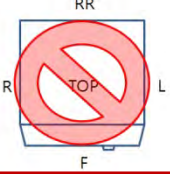

Different installation 4

- BRX Bottom is facing left side of the car.

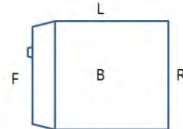

(X:90, Y:0, Z:0)

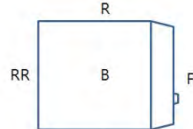

(X:90, Y:180, Z:0)

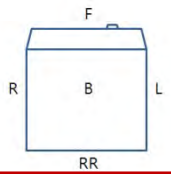

(X:90, Y:90, Z:0)

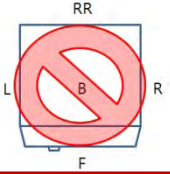

Different installation 5

- BRX top is facing front side of the car.

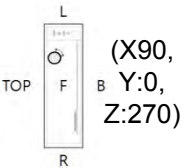

(X:90, Y:0, Z:270)

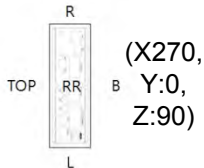

(X:270, Y:0, Z:90)

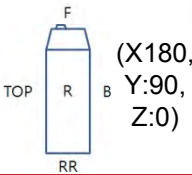

(X:180, Y:90, Z:0)

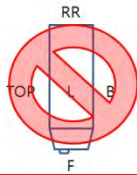

Different installation 6

- BRX top is facing rear side of the car.

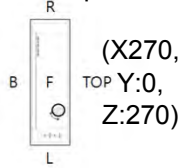

(X:270, Y:0, Z:270)

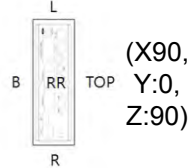

(X:90, Y:0, Z:90)

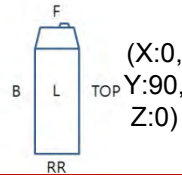

(X:0, Y:90, Z:0)

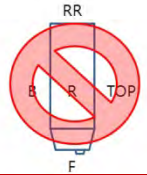

DVR CONFIGURATION: G-SENSOR LEVELS

G-Sensor

Axis X	0	Axis Y	0	Axis Z	0
Level X	3	Level Y	3	Level Z	3

Set G-Sensor Trigger level [1(insensitive)-5(The most sensitive)]

If G-sensor sensitivity value is high (5), it may be too sensitive, it will detect even a light impact or light turn. If G-sensor sensitivity value is a low setting (1), it might not detect a notable incident.

Sensitivity should be set in consideration of a vehicle's suspension and also the road condition.

G sensor X value: Front & Back (i.e. hard brake or quick acceleration)

G sensor Y value: Left & Right (i.e sharp turn)

G sensor Z value: Up & Down (prominence and depression)

Remocon

Enable

Remote controller Enable button.

(this feature will be available soon)

DVR CONFIGURATION: RECORD SETTINGS

RECORD



Video Type	<p>Select your Video Standard(Camera type.). This Video Standard(NTSC/PAL) is just for FPS calculation. This is different from your DVR video standard. To change your DVR video standard, set your video standard at service menu of DVR. Refer to page 21.</p>	
Camera	FPS	<p>NTSC: D1 60fps, HD1 120fps, CIF 240fps PAL: D1 50fps, HD1 100fps, CIF 240fps</p>
	TYPE	<p>No record Normal: Continuous recording when powered on Event: Recording by event (trigger or shock) Normal + Event: 1fps record before event. Record according to the setting when event.</p>

DVR CONFIGURATION: RECORD SETTINGS CONT'D

RemainedFPS: 40/60

Resolution: D1

Quality: High

EventRecord: Pre: 5 sec, Post: 10 sec

Encryption: [] (1000~9999)

Overwrite

Remained FPS		Show remained FPS / Total FPS
Resolution		D1: 720x480(NTSC), 720x576(PAL) HD1: 720x240(NTSC), 720x288(PAL) CIF: 360x240 (NTSC), 360x288(PAL)
Quality		Normal: Small file size, low picture quality. High: Super: Large file size, good picture quality.
Event Record	Pre	Pre-event-record time is 0~5sec.
	Post	Post-event-record time is 0~1hour.
Encryption		Stream password. Enter 4 number from 1000 to 9999 as a password. Once you set it, playback can be done only with the right password. [Caution] Be careful not to forget the password once you set it. For security reasons, loss of passwords will require the SD card to be returned to the distributor.
Overwrite		The image data is overwrites the oldest files when the SD memory is full.

DVR CONFIGURATION: MOTION DETECTION

EVENT

Motion Detection

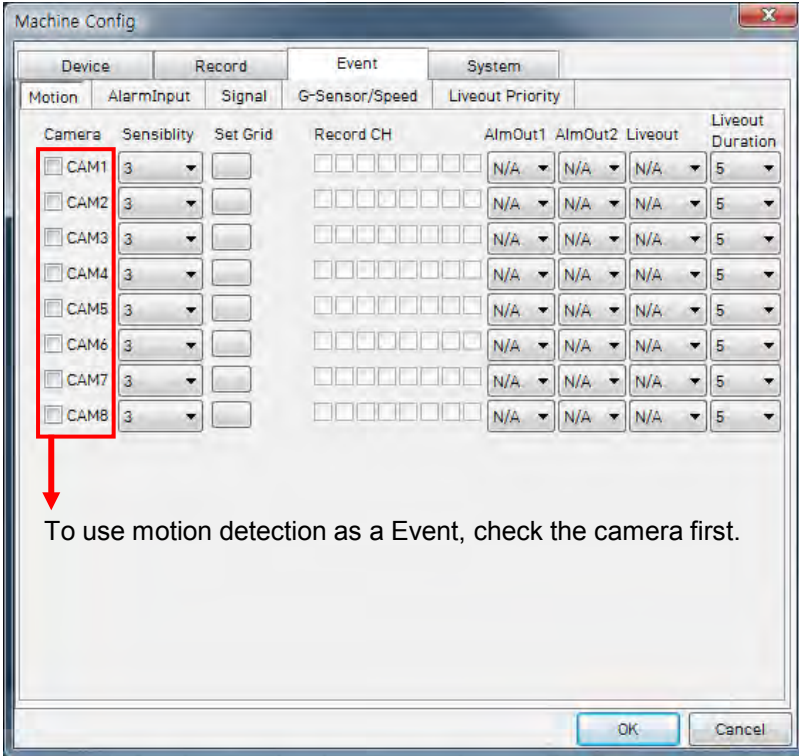

Sensitivity	1(Insensitive)~5(The most sensitive)
Set Grid	Default setting: All area is motion detecting area. To disable motion detect, click blocks and make it to black.
Record CH	Select motion event record channel
Alarm out1	Set alarm out 1 duration from 0~∞
Alarm out2	Set alarm out 2 duration from 0~∞
Live out	Set Live display channel
Live out Duration	Set Live display duration. Live display channel will automatically change to the default live display after duration.

DVR CONFIGURATION SETTING

Alarm Input

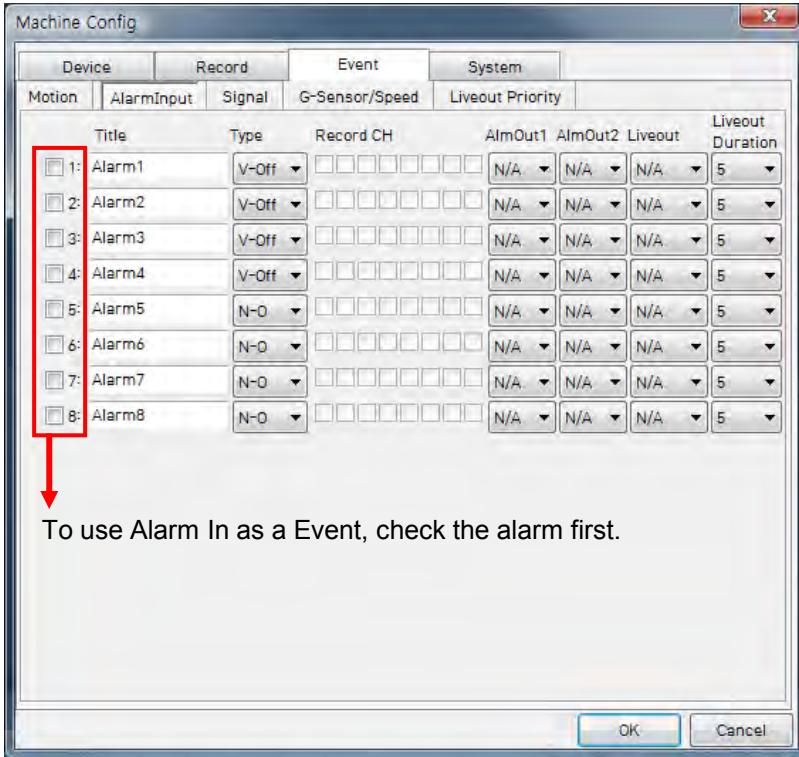

Title	Set Alarm In title
Type	Set Alarm In Type Alarm In 1~4: Voltage ON / Voltage OFF. Alarm In 5~8: Normal Close / Normal Open
Record CH	Select Alarm record channel
Alarm out1	Set alarm out 1 duration from 0~∞
Alarm out2	Set alarm out 2 duration from 0~∞
Live out	Set Live display channel
Live out Duration	Set Live display duration. Live display channel will automatically change to the default live display after duration.

DVR CONFIGURATION SETTING

Signal

The screenshot shows the 'Machine Config' window with the 'Signal' tab selected. The window is divided into four main sections: Device, Record, Event, and System. Under the 'Signal' tab, there are sub-sections for Motion, AlarmInput, Signal, G-Sensor/Speed, and Liveout Priority. The main configuration area contains a table with the following columns: Title, Record CH, AlmOut1, AlmOut2, Liveout, and Liveout Duration. There are four rows of configuration, numbered 1 to 4.

	Title	Record CH	AlmOut1	AlmOut2	Liveout	Liveout Duration
1:	Left	<input type="checkbox"/> <input type="checkbox"/> <input type="checkbox"/> <input type="checkbox"/> <input type="checkbox"/> <input type="checkbox"/> <input type="checkbox"/> <input type="checkbox"/> <input type="checkbox"/> <input type="checkbox"/>	N/A	N/A	N/A	5
2:	Right	<input type="checkbox"/> <input type="checkbox"/> <input type="checkbox"/> <input type="checkbox"/> <input type="checkbox"/> <input type="checkbox"/> <input type="checkbox"/> <input type="checkbox"/> <input type="checkbox"/> <input type="checkbox"/>	N/A	N/A	N/A	5
3:	Brake	<input type="checkbox"/> <input type="checkbox"/> <input type="checkbox"/> <input type="checkbox"/> <input type="checkbox"/> <input type="checkbox"/> <input type="checkbox"/> <input type="checkbox"/> <input type="checkbox"/> <input type="checkbox"/>	N/A	N/A	N/A	5
4:	Reverse	<input type="checkbox"/> <input type="checkbox"/> <input type="checkbox"/> <input type="checkbox"/> <input type="checkbox"/> <input type="checkbox"/> <input type="checkbox"/> <input type="checkbox"/> <input type="checkbox"/> <input type="checkbox"/>	N/A	N/A	N/A	5

At the bottom of the window, there are 'OK' and 'Cancel' buttons.

Title	Set Signal title
Record CH	Select Signal record channel
Alarm out1	Set alarm out 1 duration from 0~∞
Alarm out2	Set alarm out 2 duration from 0~∞
Live out	Set Live display channel
Live out Duration	Set Live display duration. Live display channel will automatically change to the default live display after duration.

DVR CONFIGURATION: VEHICLE SPEED

G-Sensor / Speed

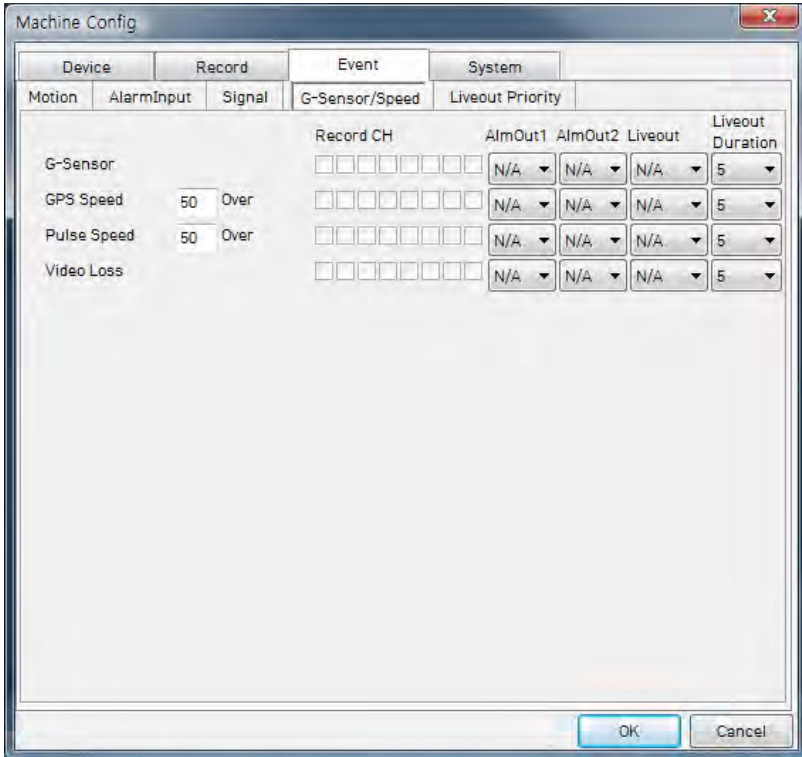

GPS Speed	Set GPS speed, Exceeding this speed will trigger.
Pulse Speed	Set Car speed pulse speed, Exceeding this speed will trigger.
Record CH	Select which channel will record when speed i
Alarm out1	Set alarm out 1 duration from 0~∞
Alarm out2	Set alarm out 2 duration from 0~∞
Live out	Set Live display channel
Live out Duration	Set Live display duration. Live display channel will automatically change to the default live display after duration.

DVR CONFIGURATION: VIDEO CHANNEL PRIORITY

Live out Priority

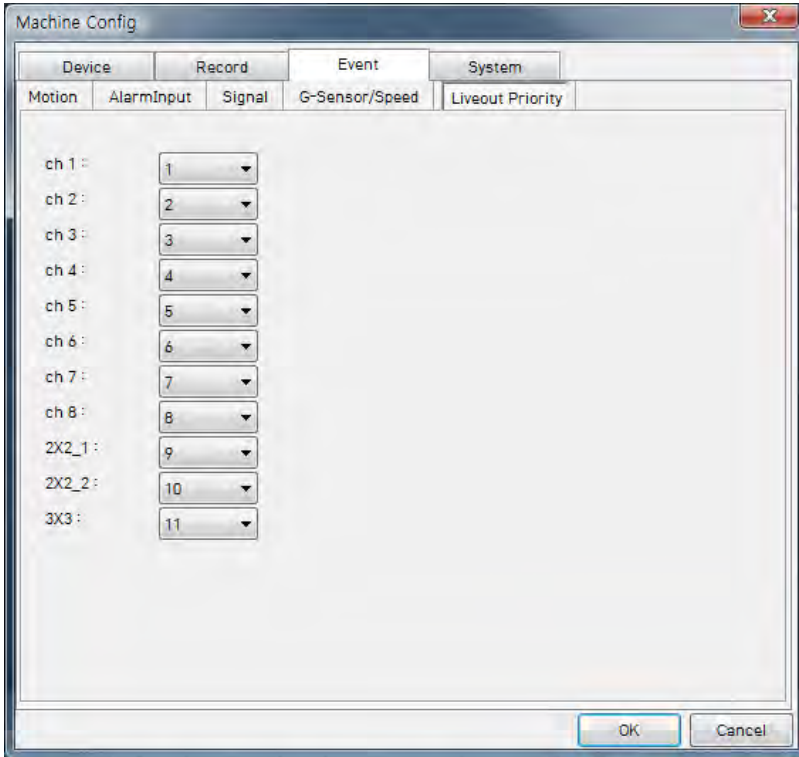

This menu is to set the default live display priority.
1 is the highest priority display channel on the live screen.

2x2_1 : quad mode (cam1~cam4)
2x2_2 : quad mode (cam5~cam8)
3x3 : 8 split mode (cam1~cam8)

If you set 2x2_1 as 1 and turn on the DVR, the first screen will be always quad (Cam1~Cam4) mode.

DVR CONFIGURATION: SYSTEM SETTINGS

SYSTEM

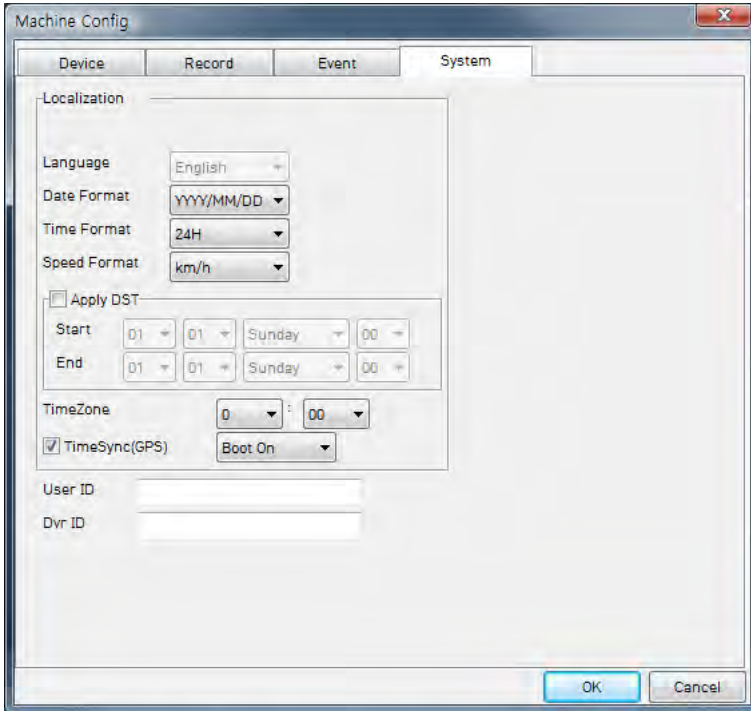

Language	Set your DVR language
Date Format	Set your DVR Date Format.
Time Format	Set your DVR Time Format
Speed Format	Set your DVR Speed Format
Apply DST	Set Daylight Saving Time
Time Zone	Set your Time zone
Time Sync (GPS)	Set time synchronize time. Boot on or every day 0~23 o'clock
USER ID	Set Driver Name
DVR ID	Set Car plate number or Vehicle ID

Connecting Removable HDD/SSD to your PC

1. Connect Removable SSD/HDD to your PC through provided USB mini cable.
2. Run "DVR Viewer BRX2000A"
3. Click [HDD load] icon.



[HDD load] icon

4. Select HDD

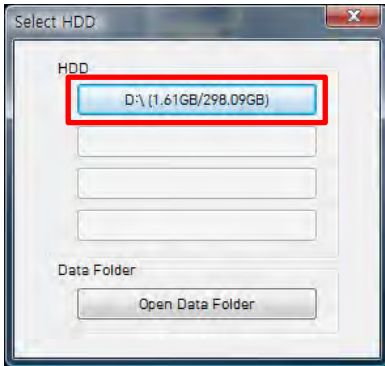

[NOTE]

Up to 4 removable HDD/SSD
can be connected to a PC at the same time.

5. Then calendar Search screen will be on the screen.



Opening the Data Folder

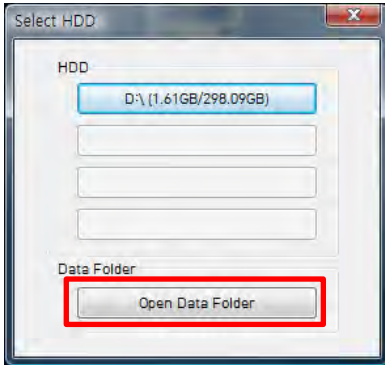

Use this button after you download the whole removable HDD data into a folder in your PC.

If you copied all removable HDD files include folders into the [aaa] folder as below,

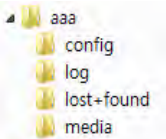

click Open Data Folder button and then select [aaa] folder to open the data.

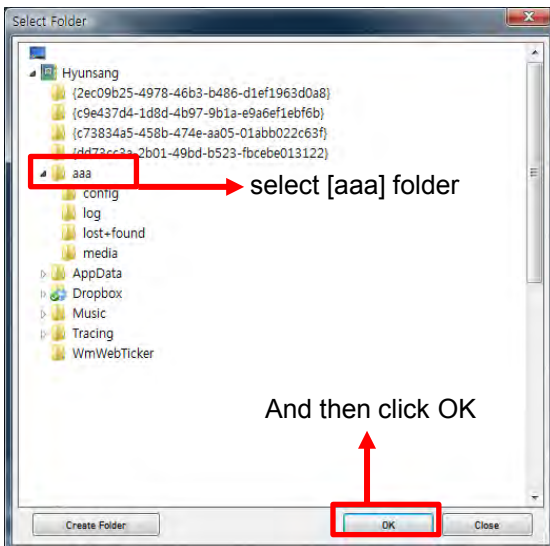

Playback screen

Camera title (Resolution)
Date/Time

Speed Pulse speed/Signal/Google map/Alarm In1-8

Playback control Buttons

Slide Bar

Playback can be controlled with the buttons in bottom. The slider helps for easy searching of the desired playback position or time.

In case that the user wants to search the other date, click [Calendar Search] Button at the upper layer of screen. Then Calendar Search windows open and the other dates can be played back accordingly.

















[Calendar Search] Button

For more information about calendar search, refer to page 47.

Main buttons / Playback control buttons

Main Buttons



	HDD Load		Calendar Search		Print Image
	File Load		Event Search		Backup
	Close Data		Privacy Set		Backup List
	View Information		Save Jpg		Setting
	Select Layout		Save AVI		About

Playback control Buttons

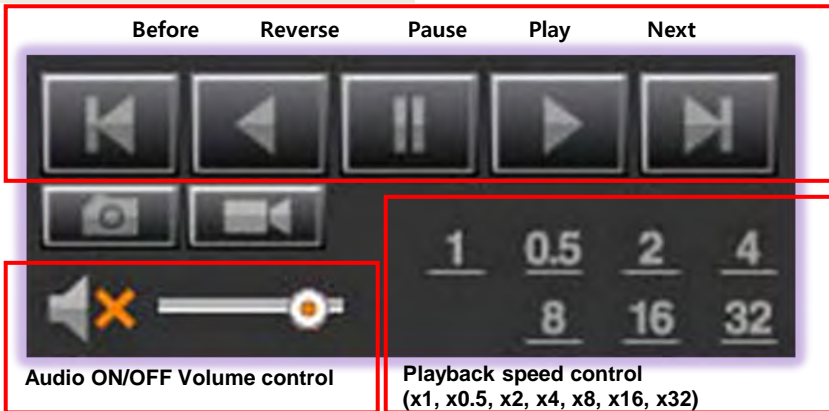

Before Reverse Pause Play Next

Audio ON/OFF Volume control

Playback speed control
(x1, x0.5, x2, x4, x8, x16, x32)

 Converting the captured file to JPEG format.

 Recording the file which is currently played back in the software.

Select Display layout

Click [Select Layout] button and then window for layout selection appears.



[Select Layout] button



Window for layout selection

Click this icon for returning to the previous screen.

[Select Layout] button

The screenshot shows the BRX2000A software interface. The top toolbar contains various icons, with the [Select Layout] button (a 3x3 grid icon) highlighted by a red box. A context menu is open over the main display area, showing options for Display Ratio, Mirror Mode, and Camera. The Camera menu is expanded, showing a list of cameras from CAM1 to CAM8, with CAM1 selected. The main display area shows multiple camera feeds, including a driver's view (CAM1) and external views (CAM2, CAM3, CAM4, CAM5, CAM6, CAM7, CAM8). The bottom of the interface shows a playback control bar with a timeline and various settings.

To see 1 camera only, double-click the screen.
Or right-click on screen and select camera

Return to multi-screen mode, double click screen.

Display Ratio	Select display ratio among original, TV(4:3), fit to window
Mirror Mode	Software mirror ON/OFF function

Viewing GPS and G-Sensor Information

Click [View Information] button during playback.



[View Information] button

BRX can record not only video & audio data of 8 Channels but also useful driving information of vehicles such as GPS position, speed, left/right signal, brake signal and speed pulse & G-sensor information. In addition, 8 alarm inputs can be interfaced and trigger the recording (such as overhead lights, brake, door opening).

All of the above information can be played back and analyzed through the BRX DVR PC Viewer Software.

Check the box to see the information like G-sensor graph, Speed graph etc.

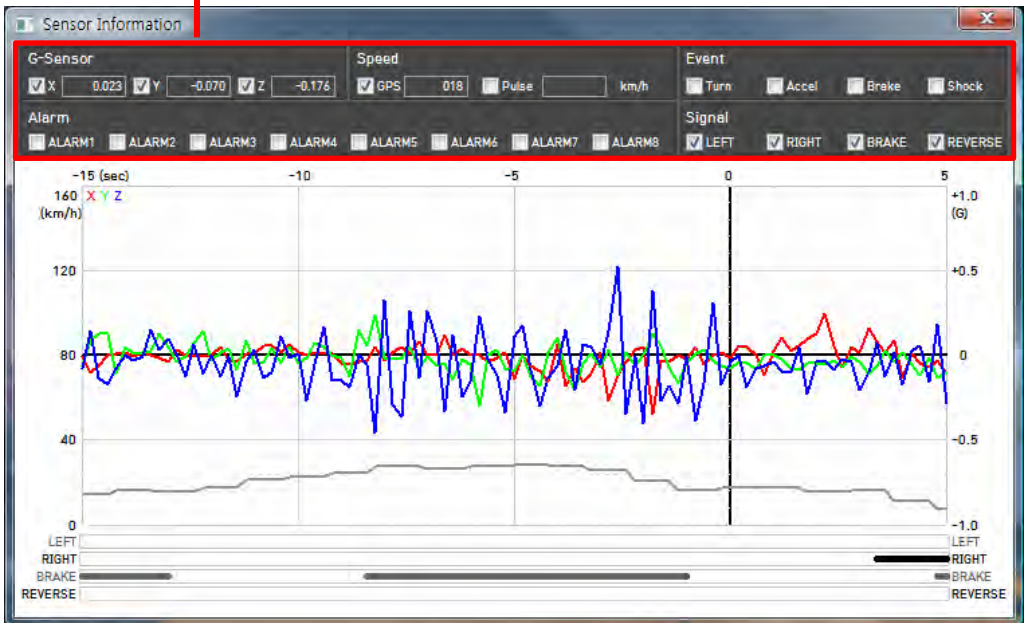

The data of G-Sensor (X : red, Y : green, Z : blue) & speed (grey) are displayed as graphs and Alarms & Car Signals are displayed as dotted lines or continuous lines upon its occurrence or trigger.

Google™ Maps Integration

Click [Google map] button during playback.

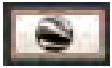

[Google map] button

To see the route & position on the Google map, the GPS data should be recorded with video.

To see the map, the PC must be connected to the Internet.

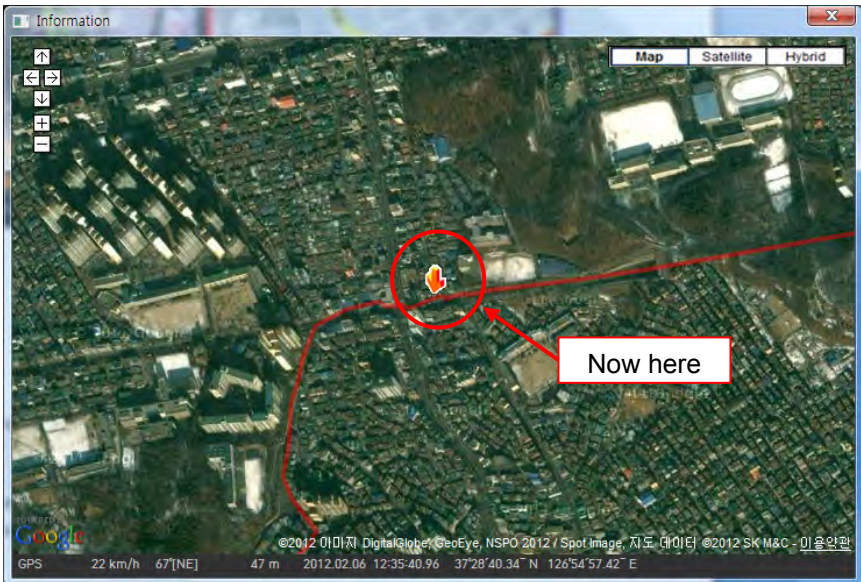
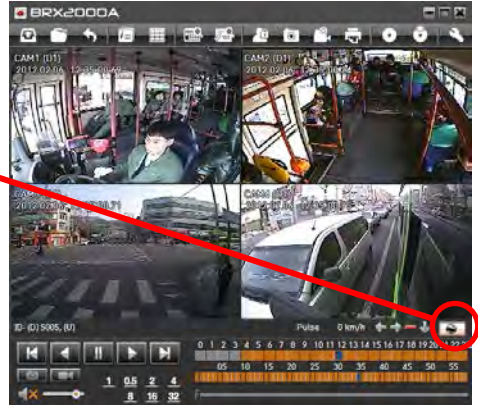

The playback position will be shown on the map with an arrow.
The red line show the route taken.

Multi-Window Playback

The Main DVR viewer, Information Window, and Google Maps Window can be displayed on the same monitor at the same time and their size can be adjusted individually.

3 different windows can work as an integrated analysis software, which improves the efficiency of the security/fleet management.

The following screen is the common example of the operation. Multi-monitors can be supported and 3 windows can be separately displayed at different monitors.

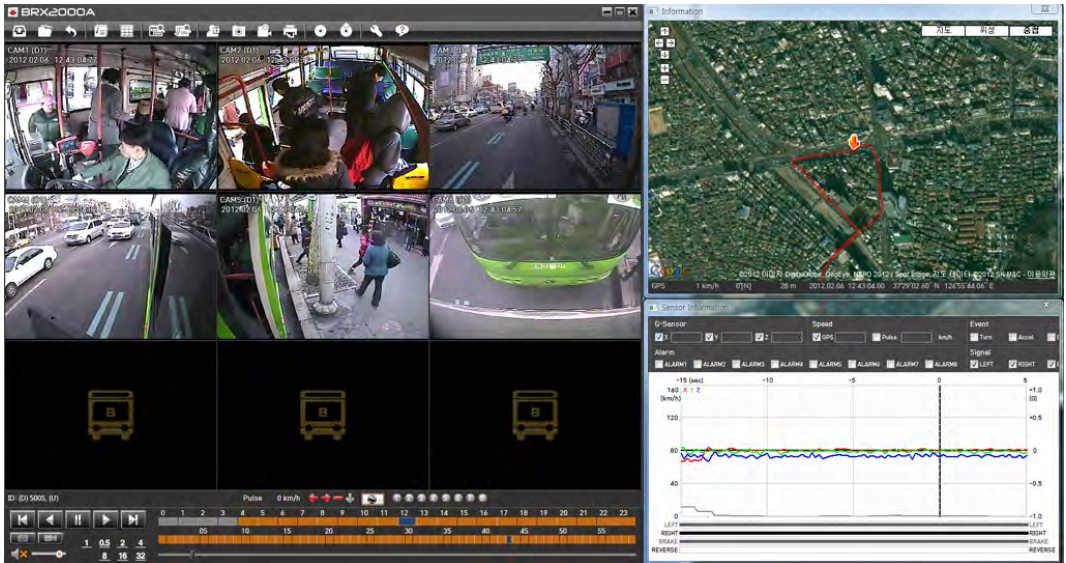

Calendar Search

Click [Calendar Search] button during playback to search the other date.

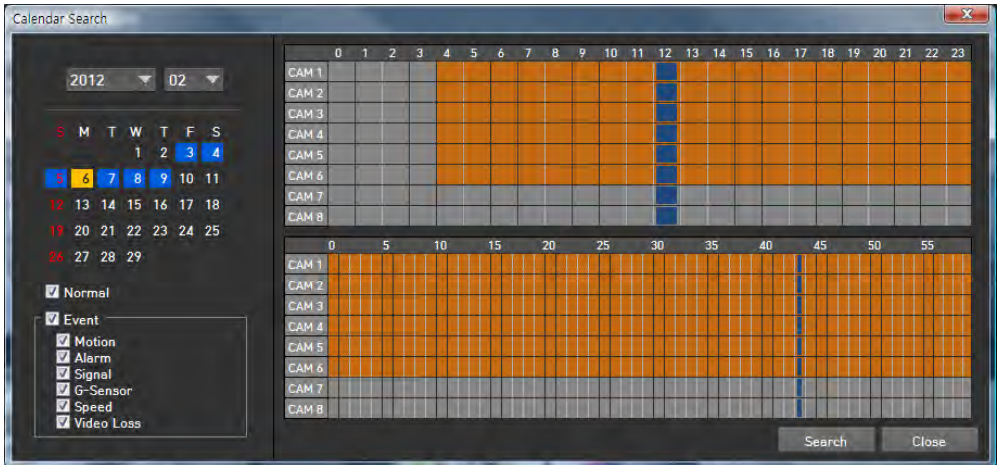

[Calendar Search] button

The screenshot shows a software window titled "Calendar Search". On the left, there is a date selection interface for the year 2012 and month 02. A calendar grid shows days from 1 to 29, with the 3rd, 4th, 7th, 8th, and 9th highlighted in blue. Below the calendar are checkboxes for "Normal", "Event", "Motion", "Alarm", "Signal", "G-Sensor", "Speed", and "Video Loss", all of which are checked. The main area of the window contains two grid views. The top grid shows data for 8 cameras (CAM 1 to CAM 8) over a 24-hour period (0 to 23). The cells from hour 4 to 11 are filled with orange, and the cell for hour 12 is filled with blue. The bottom grid shows data for the same 8 cameras over a 55-minute period (0 to 55). The cells from minute 0 to 30 are filled with orange, and the cell for minute 30 is filled with blue. At the bottom right of the window are "Search" and "Close" buttons.

Dates containing recorded data are to be marked with box of Orange color.

Once the selected date is clicked, the hours containing recorded data are marked with Orange color, too.

Click on the selected hour opens the minute table with Orange color.

The selected hour/minute is marked in blue color.

After then, click [Search] Button.

Event Search

Click [Event Search] button to quickly search for events only.



[Calendar Search] button

[Event Search] BRX can access to the data of G-Sensor Trigger, Car Signal Information, Alarm or speed with video/audio, which means that user can easily search and playback the classified data by the different conditions.

This is the case of event search, the files of speed over 60Km GPS speed are listed like below;

1. Set the search range first.

2. Set event condition.

3. Click Search.

4. Select an event to playback

5. Click Goto Video for playback

No	Date/Time	G-Sensor	Signal	Alarm	Speed
1	2012.02.06 05:08:57				60/0
2	2012.02.06 05:09:17				60/0
3	2012.02.06 05:09:44				60/0
4	2012.02.06 05:10:45				60/0
5	2012.02.06 05:11:08				60/0
6	2012.02.06 05:11:36				62/0
7	2012.02.06 05:53:30		BRAKE		60/0
8					61/0
9					61/0
10	2012.02.06 09:10:02				61/0
11	2012.02.06 09:26:26				60/0
12	2012.02.06 10:10:28		BRAKE		60/0
13	2012.02.06 11:14:27		BRAKE		60/0
14	2012.02.06 12:05:50		BRAKE		60/0

This means GPS Speed/Car Pulse Speed

Privacy Set

The BRX can set up a Privacy region on each channel to protect the people/information from unnecessary disclosure to public.

The set privacy region becomes blurred in case of back up the original data to JPG, AVI and export to any other report.

Click [Privacy Set] button to set privacy region.



[Privacy Set] button

Click the area to hide on the picture and make it sure that the area changes.

[Before set the privacy region]

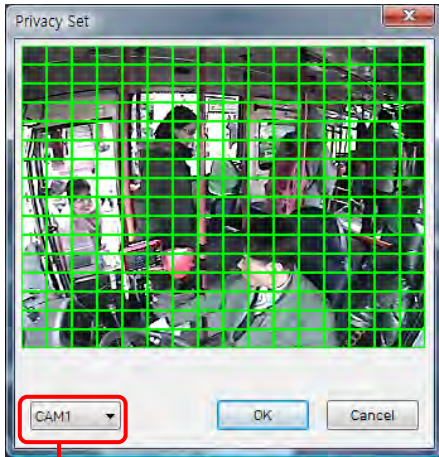

Select Camera

[After set the privacy region]

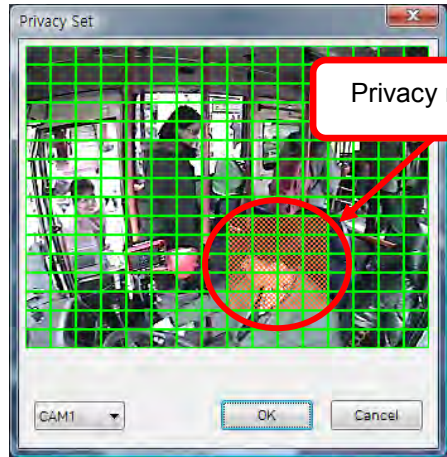

Each screen is divided to 256 regions for set Privacy setting.

Save JPG Files & Convert to AVI

Pause the playback and click [Save Jpg] button to make a JPG file.



[Save Jpg] button

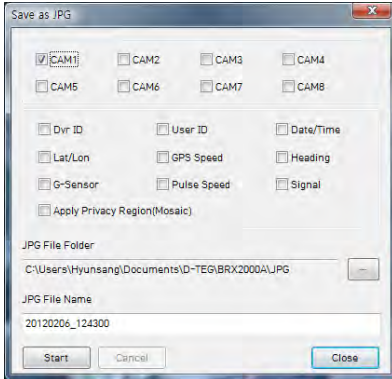

Pause the playback and click [Save AVI] button to make an AVI file.



[Save AVI] button

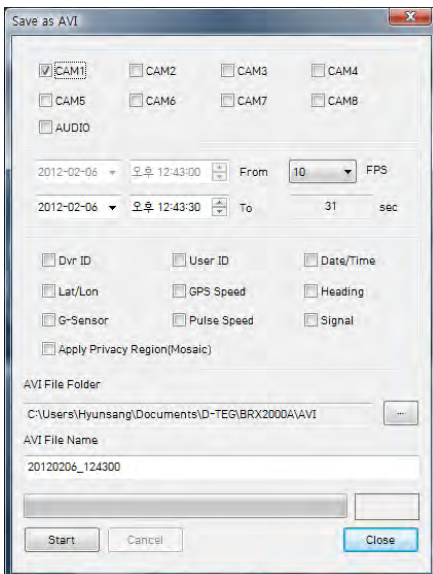

Print Image

Pause the playback and click [Print Image] button to print out.



[Print Image] button

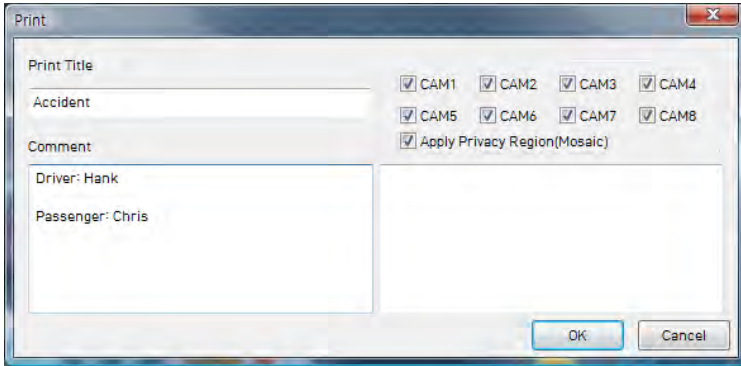

Type in the Title [Print Title] & any comments [Comment] using the Keyboard.

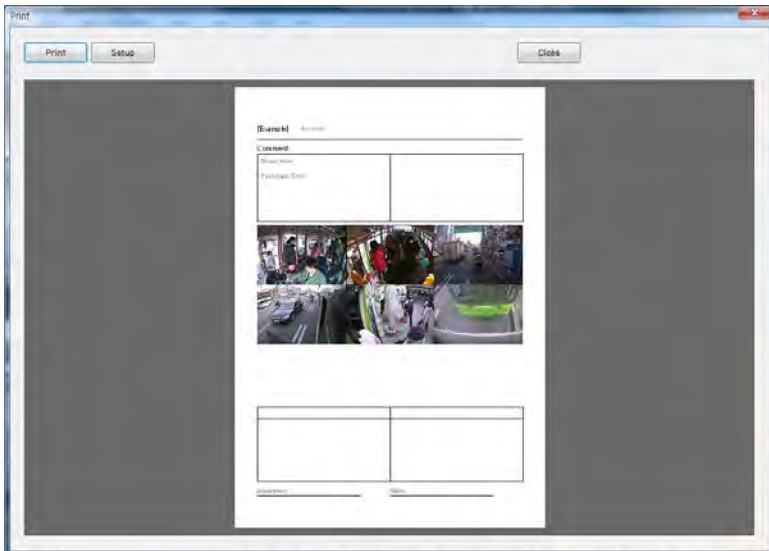

Data Backup

Click [Backup] button to backup the files to the PC.



[Backup] button

Backup Accident Video

CAM1 CAM2 CAM3 CAM4
 CAM5 CAM6 CAM7 CAM8

2012-02-06 오후 12:43:00 From
2012-02-06 오후 12:43:59 To 60 sec

Dvr ID 5005
User ID User

Memo Title
Memo

Folder C:\Users\Hyunsang\Documents\D-TEG\BRX200...

Type cross road

Start Cancel Close

Type means a folder name.
Need this to start backup.

Type in the Memo Title & Memo using the Keyboard.

And then set the Type (Folder name) and click start button.

Backup List Search

Click [Backup List] button to playback backup file.



[Backup List] button

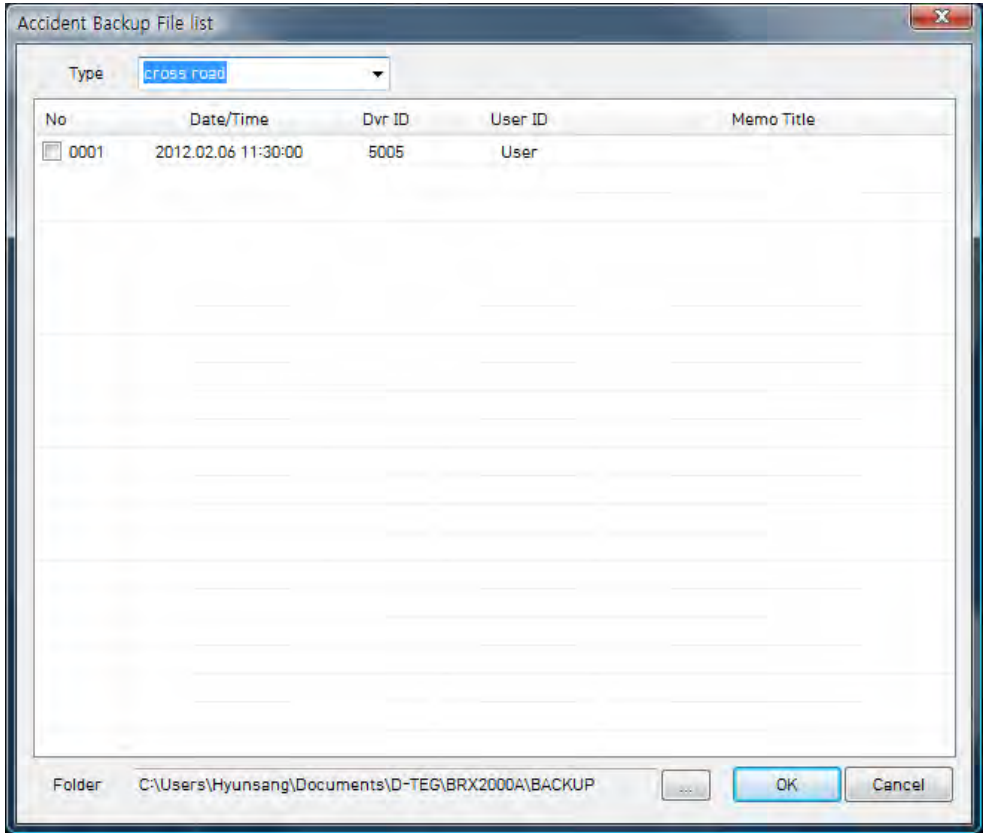

Select Type to search.

Under selected type, file list shows up with the information of time, DVR ID, USER ID.

Select the required file and click [OK] Button.

About

Click [About] button to verify the product version and information.



[About] button

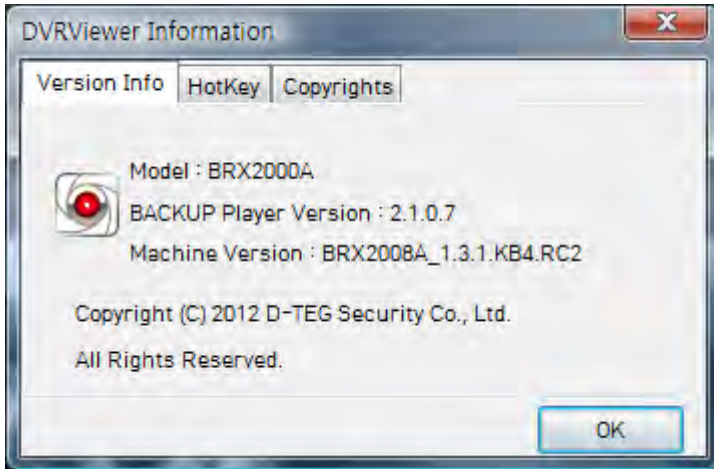

Click [HotKey] tap to check the hot key (simplified button) for the functions of DVR Viewer Software.

Specifications

Function	Detail specification
Recording Channels	8 Video channels, 8 Audio channels (NTSC/PAL)
Video/Audio Out	1 (Front) + 1 (Rear)
Video Codec	H.264
Audio Codec	G.711
Recording Resolution	NTSC : 720 x 480, 720 x 240, 360 x 240 PAL : 720 x 576, 720 x 288, 360 x 288
Alarm In / Alarm Out	8 / 2
LED	Power, Rec, Alarm, LAN
Removable Storage	SATA Interface, 2.5", HDD or SSD, Key Lock
External Device	USB Host : 1 (Front) + 1 (Rear)
LAN	10 / 100 Mbps
Dimensions	1DIN : 178mm(W) x 50mm(H) x 170mm(D)
G-Sensor	Internal 3 Axis
Serial Port	RS-232C x 2
GPS Port	External GPS 1EA
Signal	5 : Left, Right, Brake, Reverse, Speed Pulse, *RPM
Recording frame rate	NTSC : 60(D1) / 120(Half-D1) / 240(Cif) fps PAL : 50(D1) / 100(Half-D1) / 200(Cif) fps
Input Device	*Remote Controller (IR), Front Button : 10 EA
Power Output	DC 12V : 1 (Front) + 1 (Rear)
Ambient Temp.	-10°C ~ 60°C
Ambient Humidity	0 ~ 90 %
Shock Tolerance	3G (Only SSD)
Power Input	DC 8 ~ 40 V

(*) Available from October, 2012

MICRO DVR



D-Teg America, LLC
600 Morse Ave., Unit A
877-601-9918
info@d-teg.com
www.d-teg.us

MADE IN KOREA