

DH-HAC-HFW1801D

4K HDCVI IR Bullet Camera



- 120dB True WDR, 3D NR
- Max. 4K resolution
- CVI/CVBS/AHD/TVI switchable
- Fixed lens (3.6mm; 6mm optional)
- Max. IR length 80m, smart IR
- IP67, 12V±30%DC



System Overview

Experience 4K video surveillance with the simplicity of reusing existing coaxial infrastructure. The 4K HDCVI camera adopts a powerful Dahua ISP and advanced 1/2.7" CMOS sensor, which provides superior high quality images. In addition, the camera features broadcast-quality audio to provide enhanced supplementary evidence collection. Ultra-high definition and a complete set of features makes the 4K HDCVI camera an ideal choice for mid to large-size businesses and projects where both highly reliable surveillance and construction flexibility are demanded.

Functions

4 Signals over 1 Coaxial Cable

HDCVI technology supports 4 signals to be transmitted over 1 coaxial cable simultaneously, i.e. video, audio*, data and power. Dual-way data transmission allows the HDCVI camera to interact with the HCVR, such as sending control signal or triggering alarm. Moreover, HDCVI technology supports PoC for construction flexibility.

* Audio input is available for some models of HDCVI cameras.

Long Distance Transmission

HDCVI technology guarantees real-time transmission at long distance without any loss. It supports up to 700m transmission for 4K and 4MP HD video via coaxial cable, and up to 300m via UTP cable.

*Actual results verified by real-scene testing in Dahua's test laboratory.

Simplicity

HDCVI technology inherits the born feature of simplicity from traditional analog surveillance system, making itself a best choice for investment protection. HDCVI system can seamlessly upgrade the traditional analog system without replacing existing coaxial cabling. The plug and play approach enables full HD video surveillance without the hassle of configuring a network.

Broadcast-quality Audio

Audio information is used as supplementary evidence in video surveillance applications. The HDCVI camera supports audio signal transmission over coaxial cable. In addition, it adopts unique audio processing and transmission technology that best restores source audio and eliminates noise, guaranteeing the quality and effectiveness of collected audio information.

Multiple-formats

The camera supports multiple video formats including HDCVI, CVBS, and other two common HD analog formats in the market. This feature makes the camera compatible with not only XVRs, but also most existing HD/SD DVRs.

*Use OSD menu to switch HDCVI to other video formats. Use PFM820 UTC Controller to switch CVBS to HDCVI video format.

Wide Dynamic Range

Embedded with industry leading wide dynamic range (WDR) technology, vivid pictures are achieved even in the most intense contrast lighting conditions. True WDR (120dB) optimizes both the bright and dark areas of a scene at the same time to provide usable video.

Advanced 3DNR

3DNR is noise reduction technology that detects and eliminates random noises by comparing two sequential frames. Dahua's advanced 3DNR technology allows remarkable noise reduction with little impact to sharpness, especially under limited lighting condition. Besides, the advanced 3DNR effectively decreases the band width and saves the storage space.

Protection

The camera's outstanding reliability is unsurpassed due to its rugged design. The camera is protected against water and dust with IP67 ranking, making it suitable for indoor or outdoor environments.

Supporting ±30% input voltage tolerance, this camera suits even the most unstable power supply conditions. Its 4KV lightning rating provides protection against the camera and its structure from the effects of lightning.

Technical Specification

Camera

Image Sensor	1/2.7 inch CMOS
Effective Pixels	3840 (H)×2160 (V), 4K
Electronic Shutter Speed	PAL: 1/3s-1/100000s NTSC: 1/4s-1/100000s
Minimum Illumination	0.03Lux/F2.0, 30IRE, 0Lux IR on
IR Distance	Distance up to 80m (262.47ft)
IR On/Off Control	Auto/manual
IR LED Number	2
Pan/Tilt/Rotation Range	Pan: 0°-360° Tilt: 0°-90° Rotation: 0°-360°

Lens

Lens Type	Fixed-focal				
Mount Type	M12				
Focal Length	3.6mm; 6mm				
Max. Aperture	F2.0				
Angle of View	3.6mm: 104°×87°×47° (diagonal×horizontal×vertical) 6mm: 62.4°×54.7°×31.3° (diagonal×horizontal×vertical)				
Iris Type	Fixed iris				
Close Focus Distance	1.8m/3.6m (5.91ft/11.81ft)				
DORI Distance	Lens	Detect	Observe	Recognize	Identify
	3.6mm	107m (351ft)	43m (141ft)	21m (69ft)	11m (36ft)
	6mm	160m (525ft)	64m (210ft)	32m (105ft)	16m (52ft)

Video

Video Frame Rate	CVI: 4K@15fps; 5M@20fps; 4M@25fps/30fps CVBS: PAL/NTSC AHD: 5M@20fps; 4M@25fps/30fps TVI: 5M@20fps; 4M@25fps/30fps
Resolution	4K (3840×2160); 5M (2592×1944); 4M (2560×1440); 960H (960× 576/960×480)
Day/Night	Auto switch by ICR
BLC	BLC/HLC/WDR
WDR	120dB/WDR
White Balance	Auto; manual
Gain Control	Auto; manual
Noise Reduction	2D&3D NR
Smart IR	Yes
Electronic Defog	Yes
Digital Zoom	4X
Mirror	Off/On
Privacy Masking	Off/On (8 Area, Rectangle)

Certifications

Certifications	CE (EN55032, EN55024, EN50130-4) FCC (CFR 47 FCC Part 15 subpartB, ANSI C63.4-2014) UL (UL60950-1+CAN/CSA C22.2 No.60950-1)"
----------------	--

Port

Video Port	Video output choices of CVI/TVI/AHD/CVBS by one BNC port
------------	--

Power

Power Supply	12V±30% DC
Power Consumption	Max 6.5W (12V DC, IR on)

Environment

Operating Temperature	-40°C to +60°C (-40°F to 140°F); <95% (non-condensation)
Storage Temperature	-40°C to +60°C (-40°F to 140°F); <95% (non-condensation)
Protection Grade	IP67







Structure

Casing	Metal front cover+plastic main body+plastic bracket
Dimensions	241.8mm×90.4mm×90.4mm (9.52"×3.56"×3.56")
Net Weight	600g (1.32lb)
Gross Weight	760g (1.68lb)

Ordering Information		
Type	Part Number	Description
4K Camera	DH-HAC-HFW1801DP-0360B	4K HDCVI IR Bullet Camera
	DH-HAC-HFW1801DN-0360B	
	DH-HAC-HFW1801DP-0600B	
	DH-HAC-HFW1801DN-0600B	
Accessories	PFA130-E	Water-proof Junction Box (ceiling mount)
	PFA130-E+PFA152-E	Water-proof Wall Mount Bracket+Pole Mount Bracket (pole mount)
	PFM800-E	Passive HDCVI Balun
	PFM321	12V 1A Power Adapter
	PFM320	12V 2A Power Adapter
	PFM320D-015	12V 1.5A Power Adapter

Accessories

Optional:

 PFA130-E Water-proof Junction Box (ceiling mount)	 PFA130-E+PFA152-E Water-proof Wall Mount Bracket + Pole Mount Bracket (pole mount)	 PFM800-E Passive HDCVI Balun
 PFM321 12V 1A Power Adapter	 PFM320 12V 2A Power Adapter	 PFM320D-015 12V 1.5A Power Adapter

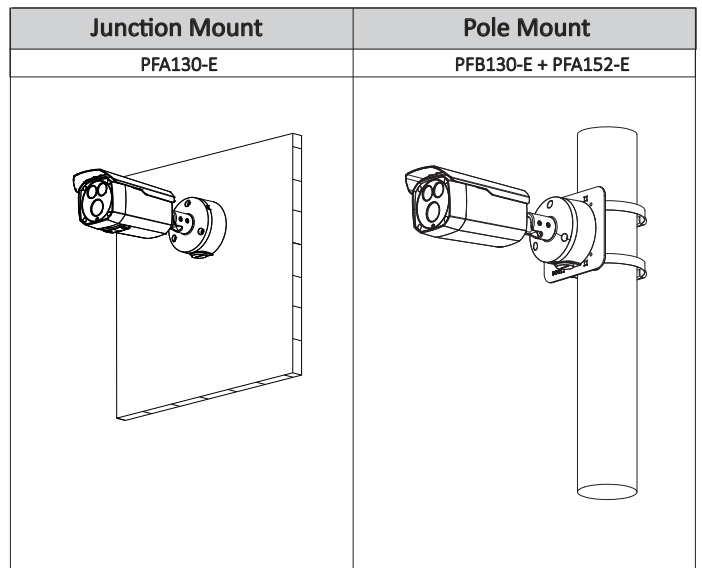

Dimensions (mm/inch)

