



Flat-Field Mega-Pixel Lens Series

Flat-Field Mega-Pixel Lens

Flat-Field IR Mega-Pixel Lens









Specifications and Lineup

Image						
	<div style="display: flex; justify-content: space-between;"> <div> <p>Full HD</p> <p>3MP</p> <p>IR</p> </div> <div> <p>Flat-Field MegaPixel</p> </div> <div> <p>Full HD</p> <p>3MP</p> <p>IR</p> </div> <div> <p>Flat-Field MegaPixel</p> </div> </div>					
Model	M13VM288IR	M13VG288IR	M13VP288IR	M13VG850IR		
Imager Size	1/2.7"	1/3"	1/4"	1/2.7"	1/3"	1/4"
Mount	CS			CS		
Focal Length	2.8-8mm			8-50mm		
Aperture Range	1.2-Close	1.2-360	1.2-Close	1.6-360		
Zoom Ratio	x2.8			x6.2		
Angle of View (Horizontal X Vertical)	1 Wide	124.3° × 65.2°		1 Wide	40.3° × 22.6°	
	27 Tele	43.0° × 24.2°		27 Tele	6.7° × 3.9°	
	1 Wide	100.1° × 72.9°		1 Wide	33.5° × 25.1°	
	3 Tele	35.8° × 26.8°		3 Tele	5.6° × 4.2°	
Operation	Focus	Manual w/Lock			Manual w/Lock	
	Zoom	Manual w/Lock			Manual w/Lock	
	Iris	Manual w/Lock	DC Auto Iris	P-Iris*	DC Auto Iris	
Focusing Range	0.3m-∞			0.3m-∞		
Operating Temperature	-20 - +60°C			-20 - +60°C		

*Connecting the lens to a camera that does not support the P-Iris technology may cause malfunction.
The lens cannot be connected to cameras that use DC auto iris or video auto iris lenses.

Image									
	<div style="display: flex; justify-content: space-between;"> <div> <p>HD</p> </div> <div> <p>Flat-Field MegaPixel</p> </div> </div>		<div style="display: flex; justify-content: space-between;"> <div> <p>HD</p> </div> <div> <p>Flat-Field MegaPixel</p> </div> </div>		<div style="display: flex; justify-content: space-between;"> <div> <p>HD</p> </div> <div> <p>Flat-Field MegaPixel</p> </div> </div>		<div style="display: flex; justify-content: space-between;"> <div> <p>HD</p> </div> <div> <p>Flat-Field MegaPixel</p> </div> </div>		
Model	M13VM246	M13VG246	M13VM308	M13VG308	M13VM550	M13VG550	M12VM412	M12VG412	
Imager Size	1/3"	1/4"	1/3"	1/4"	1/3"	1/4"	1/2"	1/3"	
Mount	CS		CS		CS		C		
Focal Length	2.4-6mm		3.0-8mm		5-50mm		4.0-12mm		
Aperture Range	1.2-Close	1.2-360	1.0-Close	1.0-360	1.4-Close	1.4-360	1.4-Close	1.4-360	
Zoom Ratio	x2.5		x2.6		x10		x3		
Angle of View (Horizontal X Vertical)	1 Wide	111.3° × 83.5°		1 Wide	92.5° × 68.2°		1 Wide	93.9° × 68.6°	
	3 Tele	47.1° × 35.4°		3 Tele	35.4° × 26.5°		2 Tele	31.4° × 23.6°	
	1 Wide	83.5° × 62.6°		1 Wide	68.2° × 50.6°		1 Wide	68.6° × 51.0°	
	4 Tele	35.4° × 26.6°		4 Tele	26.5° × 19.9°		3 Tele	23.6° × 17.7°	
Operation	Focus	Manual w/Lock		Manual w/Lock		Manual w/Lock		Manual w/Lock	
	Zoom	Manual w/Lock		Manual w/Lock		Manual w/Lock		Manual w/Lock	
	Iris	Manual w/Lock	DC Auto Iris	Manual w/Lock	DC Auto Iris	Manual w/Lock	DC Auto Iris	Manual w/Lock	DC Auto Iris
Focusing Range	0.3m-∞		0.3m-∞		1m-∞		0.3m-∞		
Operating Temperature	-20 - +60°C		-20 - +60°C		-20 - +60°C		-20 - +60°C		

<div style="display: flex; justify-content: space-between;"> <div> <p>Full HD</p> <p>3MP</p> <p>IR</p> </div> <div> <p>M13VM288IR / M13VG288IR / M13VP288IR</p> </div> </div>		<div style="display: flex; justify-content: space-between;"> <div> <p>Full HD</p> <p>3MP</p> <p>IR</p> </div> <div> <p>M13VG850IR</p> </div> </div>									
<div style="display: flex; justify-content: space-between;"> <div> <p>HD</p> </div> <div> <p>M13VM246 / M13VG246</p> </div> </div>											
		<div style="display: flex; justify-content: space-between;"> <div> <p>HD</p> </div> <div> <p>M13VM308 / M13VG308</p> </div> </div>									
		<div style="display: flex; justify-content: space-between;"> <div> <p>HD</p> </div> <div> <p>M13VM550 / M13VG550</p> </div> </div>									
		<div style="display: flex; justify-content: space-between;"> <div> <p>HD</p> </div> <div> <p>M12VM412 / M12VG412</p> </div> </div>									
											
2.4mm		2.8mm		5mm		8mm		12mm		50mm	

*Angle of view images are illustrative examples.

Delivering Uniformly High Resolution Image from Corner to Corner

The Tamron Flat-Field Mega-Pixel Lens Series delivers Mega-pixel image quality not only in the center but also in the corners of the image field, providing the mega-pixel resolution quality needed for image cropping and enlarging of image, irrespective of the location of the subject on the screen. This ensures that subject faces and other relevant information can be clearly identified and distinguished, making the Tamron Flat-Field Mega-Pixel Lens an ideal solution for high resolution network surveillance applications. In fact all lenses of the Tamron Mega-Pixel Lens Series lineup deliver Flat-Field Mega-Pixel resolution.

Screen-Wide Consistent High Resolution and High Contrast Image Quality

Wide Angle

Normal Lens

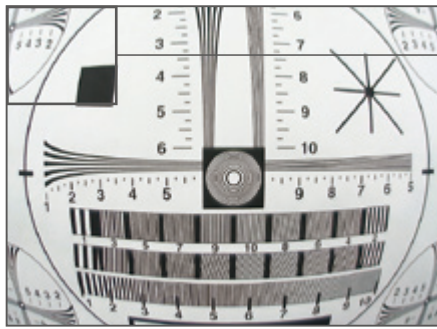

Tamron Mega-Pixel Lens

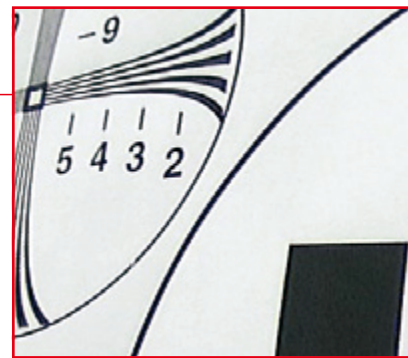
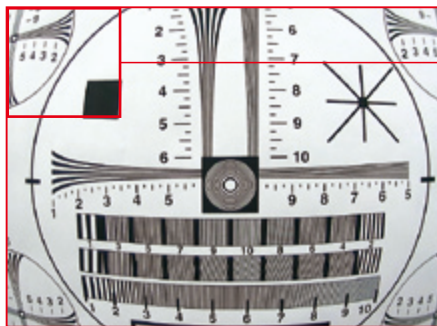

Tele Angle

Normal Lens

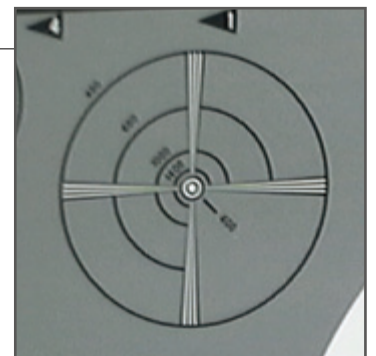
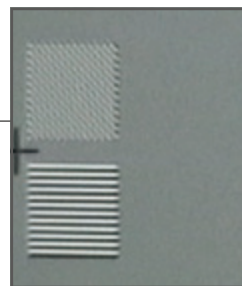
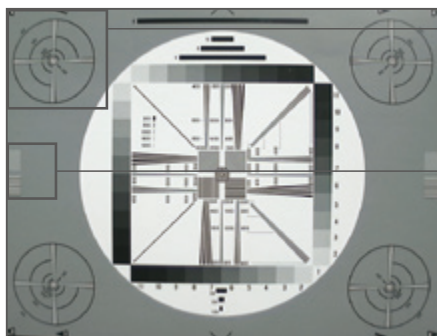

Tamron Mega-Pixel Lens

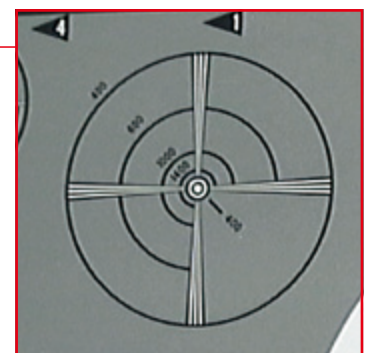
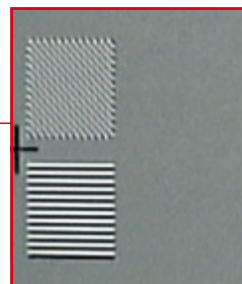
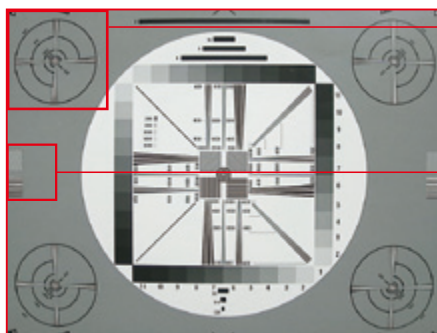

* Image taken at maximum aperture.

** Images shown are all shot using actual mega-pixel cameras and CCTV/IP lenses.

Key Mega-Pixel Technologies

Key Technologies Supporting with Mega-Pixel Compatibility

Each lens in Tamron's Mega-Pixel Vari-Focal Lens Series uses Aspherical elements to minimize optical aberrations and ensure high optical quality while maintaining a compact form. Employing innovative optical technologies, these lenses deliver high resolution and high contrast images that are sharp from the center to corner of the image field, and represent the ideal solution for application that use high quality mega-pixel cameras.

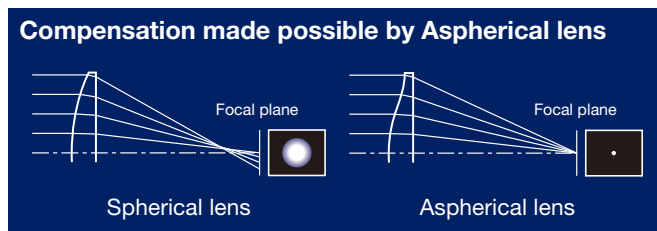

Wide Dynamic Range < M13VM308/M13VG308 >

The fast aperture of F/1.0 makes it possible to obtain vivid color images even in dim lighting conditions such as dark rooms and corridors, or in the early morning or evening hours when the ambient light would ordinarily be insufficient to capture high-quality images. A fast lens is able to gather a large amount of light, thereby enhancing the sensitivity of the camera.



■ F/1.4

■ F/1.0

F/1.0 lens has two times light gathering power compared to F/1.4 making a 1 lux camera sensitivity into a 0.5 lux sensitivity.

Multiple-Layer Coatings

Multi-coating is applied to internal and external lens surfaces to minimize ghosting and flare in backlit situations. The result is consistently sharp contrast and excellent image quality even under unfavorable lighting conditions.



Supporting up to 1/2.7" Sensors

< M13VM288IR / M13VG288IR / M13VP288IR / M13VG850IR >

The large image circle makes it possible to match with 1/2.7", as well as 1/2.8" and 1/3" sensor sizes. Due to variance in such sensor sizes, it was essential to incorporate such design.

P-Iris < M13VP288IR >

By using a stepper motor to control the iris, this lens is capable of adjusting the aperture at a position that does not cause diffraction, enabling an appropriate level of exposure by utilizing the camera shutter speed.*1 The result is that high quality, high contrast images can be recorded, even in bright outdoor areas. This fine tuning control will allow the user to acquire the best image quality delivering good depth of field at most installations.

*1 Connecting the lens to a camera that does not support the P-Iris technology may cause malfunction.
The lens cannot be connected to cameras that use DC auto iris or video auto iris lenses

Compact Design

Mega-pixel resolution is achieved while maintaining the compactness of conventional lenses.

Slip-Mount Mechanism

Each lens is equipped with a slip-mount mechanism that allows rotational adjustment of the lens after it is mounted on a camera. This allows optimal positioning of the auto-iris actuator and cable during installation.

Locking Mechanism for each Control Ring

Each control ring for zoom, focus, and iris size* can be independently locked to prevent setting displacement after installation.
(*Manual iris only)

Large Focus Rotation Angle

The rotation angle of the focus ring has been increased to achieve easier and more precise focus adjustment for Mega-Pixel cameras.



Precision Manufacturing

Each component in our Flat-Field Mega-Pixel Lenses is produced and assembled using the most advanced precision manufacturing techniques to prevent image degradation due to local blur and focus shift.

Flat-Field IR Mega-Pixel Lens

Model

M13VM288IR/M13VG288IR/M13VP288IR 2.8-8mm F/1.2

Full HD

3MP

IR

M13VG850IR 8-50mm F/1.6

3 Mega-Pixel Quality that Meets or Exceeds Full HD 1080P in Both the Visible and Near Infrared Spectrums

Two Lenses Cover 2.8mm to 50mm

The lenses cover wide angle 2.8mm to telephoto 50mm, which means that most applications can be covered by these two lenses. The horizontal angle of view are 124.3 degree at wide and 6.7 degree at tele end. (1/2.7" sensor)

Fast F Number

The full open aperture of the standard lens is F/1.2 and for the telephoto lens F/1.6. This will enable the lens to be used under low light situation yet delivering the Mega-Pixel resolution.

Compatible with Current Camera Design

Internal components in the vicinity of the imager are designed to minimize protrusion from the lens mount face for full compatibility with most surveillance camera in the market.

Superb Picture Quality

Designed to minimize color aberrations, ghost and flare for top picture quality.

3 Mega-Pixel / Full HD Resolution for 24/7 Surveillance

Near infrared radiation refracts differently from visible light, causing blurring in an image captured in the near infrared spectrum. Tamron IR Mega-Pixel Lenses utilize cutting-edge optical design technology and advanced low dispersion glass to converge the focal points of visible light and near infrared radiation, providing 3 mega-pixel image quality 24-hours a day.

Exceptional Image Quality in the Visible and Near-Infrared Spectrums

With conventional lenses, image focus shift will occur in the surveillance camera video footage, shot under the near infrared illumination. Near infrared wavelength will be refracted differently from the visible light, which results in out of focus image when switching to night mode. The Tamron IR Mega-Pixel Lens Series features the latest optical design incorporating the low dispersion glass, Aspherical element and special coating technology, which resolves the focus shift issue. As a result, the lens will provide clear image of 3 mega-pixel even in black and white mode enabling the true mega-pixel 24-hours surveillance regardless of the lighting condition.

■ Comparison of a Visible Light Lens and an IR Lens

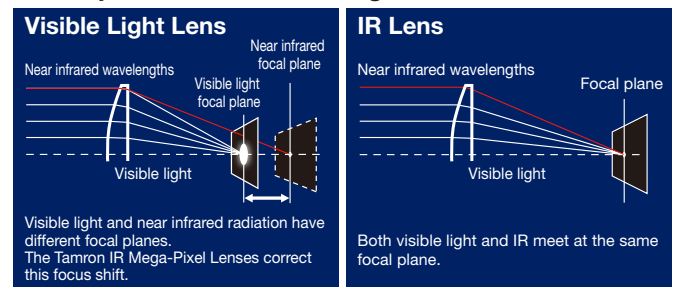

■ Visible Light (Color Mode)



■ Near Infrared Light (B/W Mode)



Dimensions

M13VM288IR

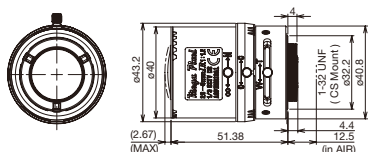

M13VM246

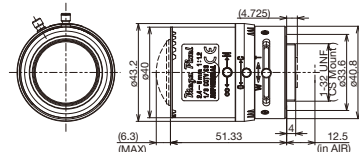

M13VM308

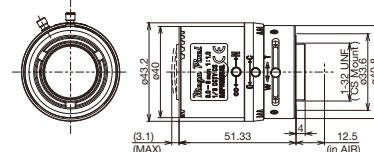

M13VG288IR

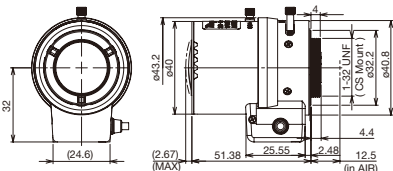

M13VG246

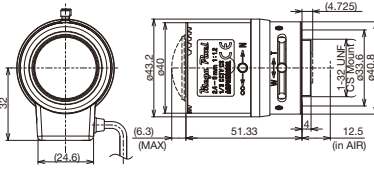

M13VG308

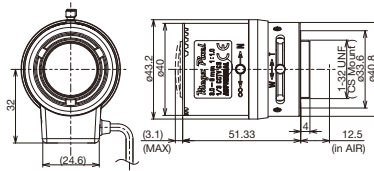

M13VP288IR

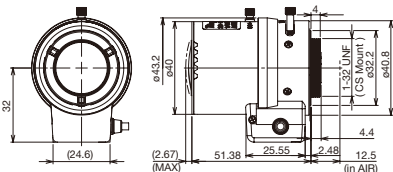

M13VM550

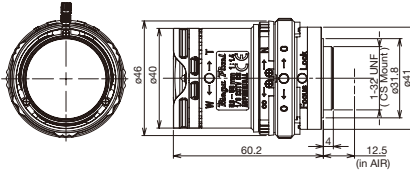

M12VM412

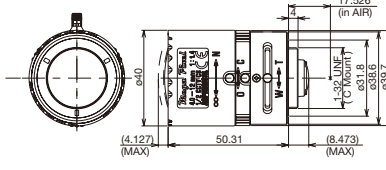

M13VG850IR

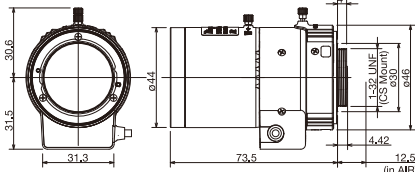

M13VG550

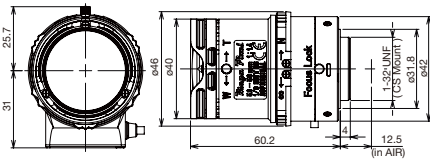

M12VG412

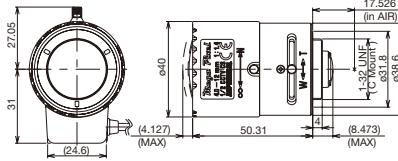

Environmental Policy

Environmentally Friendly Design

Tamron employs an environmentally-friendly design approach that requires all lens components, as well as packing materials and all peripheral elements to be free from any substances that could have an adverse impact on our environment. All of Tamron's manufacturing plants implement thorough environmental assessments when procuring materials and components to ensure that no such harmful substances are used.

Strict Chemical Substances Management System

Tamron has established a strict internal regime to monitor all chemical substances used to manufacture our lenses, and is fully compliant with RoHS, REACH and WEEE. We will continue our efforts to develop safe products that bring our customers peace of mind in addition to our high standard of quality.

Caution: Please read the instruction manual carefully before using the lens.

TAMRON

Manufacturer of precise and sophisticated optical products for a broad range of industries.

TAMRON CO., LTD. <http://www.tamron.co.jp/cctv>

1385, Hasunuma, Minuma-ku, Saitama-shi, Saitama 337-8556 JAPAN
Tel: +81-48-684-9129 Fax: +81-48-683-8594 E-mail: tokki@tamron.co.jp



Quality Assurance Activities: At Tamron, quality management activities are performed in compliance with ISO9001:2000 not only to assure product quality but to enhance customer satisfaction.

Environmental Protection: We recognize the significance of our social responsibilities. Tamron promotes corporate activities that protect the earth's environment through the establishment of a quality assurance system that is compliant with ISO14001.

