

## Technical Specifications

System Information	
CPU	Multimedia SoC (System-on-Chip)
Flash	128 MB
RAM	256 MB
Camera Features	
Image Sensor	1/2.7" Progressive CMOS
Maximum Resolution	1920x1080
Lens Type	Vari-focal, remote focus
Focal Length	f = 3 ~ 9 mm
Aperture	F1.2 (wide), F2.1 (tele)
Auto-iris	DC-iris
Field of View	38° ~ 104° (horizontal) 22° ~ 71° (vertical) 43° ~ 111° (diagonal)
Shutter Time	1/5 sec. to 1/32,000 sec.
WDR Technology	WDR Enhanced
Day/Night	Removable IR-cut filter for day & night function
Minimum Illumination	0.08 Lux @F1.2, 50 IRE (color) 0.001 Lux @ F1.2, 50 IRE (B/W)
Pan Range	360°
Tilt Range	180°
Rotation Range	360°
Pan/tilt/zoom	ePTZ:
Functionalities	48x digital zoom (4x on IE plug-in, 12x built-in)
IR Illuminators	Built-in IR illuminators, effective up to 15 meters IR LED*8
On-board Storage	MicroSD/SDHC/SDXC card slot
Video	
Compression	H.264, MJPEG & MPEG-4
Maximum Frame Rate	H.264: 30 fps at 1920x1080 MPEG-4: 30 fps at 1920x1080 MJPEG: 30 fps at 1920x1080
Maximum Streams	4 simultaneous streams
S/N Ratio	Above 52 dB
Dynamic Range	55 dB
Video Streaming	Adjustable resolution, quality and bitrate Configurable video cropping for bandwidth saving
Image Settings	Adjustable image size, quality and bit rate Time stamp, text overlay, flip & mirror Configurable brightness, contrast, saturation, sharpness, white balance, exposure control, gain, backlight compensation, privacy masks Scheduled profile settings
Audio	
Audio Capability	Audio input/output (Full duplex)
Compression	GSM-AMR, AAC, G.711
Interface	Built-in microphone External microphone input External line output
Effective Range	5 meters
Network	
Users	Live viewing for up to 10 clients
Protocols	IPv4, IPv6, TCP/IP, HTTP, HTTPS, UPnP, RTSP/RTMP/RTCP, IGMP, SMTP, FTP, DHCP, NTP, DNS, DDNS, PPPoE, CoS, QoS, SNMP, 802.1X
Interface	10Base-T/100 BaseTX Ethernet (RJ-45)
ONVIF	Supported, specification available at <a href="http://www.onvif.org">www.onvif.org</a>
Intelligent Video	
Video Motion Detection	Triple-window video motion detection

Alarm and Event	
Alarm Triggers	Video motion detection, manual trigger, digital input, periodical trigger, system boot, recording notification, camera tampering detection, PIR
Alarm Events	Event notification using digital output, HTTP, SMTP, FTP and NAS server File upload via HTTP, SMTP, FTP and NAS server
General	
Smart Focus System	Remote focus & easy focus
Connectors	RJ-45 for network/PoE connection Audio input/output AV output AC 24V power input DC 12V power input Digital input*1 Digital output*1
LED Indicator	System power and status indicator
Power Input	12V DC 24V AC IEEE 802.3af PoE Class 3
Power Consumption	DC 12V: 6.9W PoE: 9.3W AC 24V: 8.5W
Dimensions	Ø: 157 mm x 110 mm
Weight	Net: 840 g
Safety Certifications	CE, LVD, FCC Class B, VCCI, C-Tick, UL
Operating Temperature	0°C ~ 50°C (32°F ~ 122°F)
Warranty	36 months
System Requirements	
Operating System	Microsoft Windows 7/Vista/XP/2000
Web Browser	Mozilla Firefox 7~10 (streaming only) Internet Explorer 7.x or 8.x
Other Players	VLC: 1.1.11 or above QuickTime: 7 or above
Included Accessories	
CD	User's manual, quick installation guide, Installation Wizard 2, ST7501 32-channel recording software
Others	Quick installation guide, warranty card, alignment sticker, T10 torx screwdriver, screws, plastic anchors, AV cable, software CD

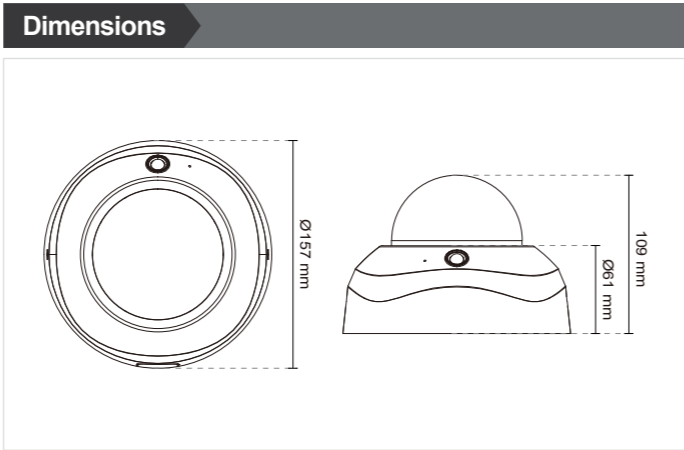

## Compatible Accessories

<b>Mounting Kits</b> <b>Corner mount</b> 	<b>Junction Box</b> 	<b>Wall Mount</b> 	<b>Power Adapter</b> <b>AA-221</b> DC 12V 	<b>AA-341</b> AC 24V 
<b>Pole Mount</b> 	<b>Pendant Mount</b> 	<b>Recessed Kit</b> 	<b>PoE Kits</b> <b>POE-IJ-1748NDN</b> 802.3af Compliant PoE Injector 	<b>Others</b> <b>AI-102</b> IR Illuminators 

All specifications are subject to change without notice. Copyright © 2013 VIVOTEK INC. All rights reserved.

Distributed by:

**VIVOTEK INC.**  
6F, No. 192, Lien-Cheng Rd., Chung-Ho, New Taipei City, 235, Taiwan, R.O.C.  
| T: +886-2-82455282 | F: +886-2-82455532 | E: sales@vivotek.com

**VIVOTEK USA, INC.**  
2050 Ringwood Avenue, San Jose, CA 95131  
| T: 408-773-8686 | F: 408-773-8298 | E: salesusa@vivotek.com

Ver 1.0



# Fixed Dome Network Camera FD8163



Full HD • Smart Focus System •  
Smart IR • PIR

VIVOTEK FD8163 is an easy-to-use fixed dome network camera, featuring 2-Megapixel or 1080p Full HD resolution with superb image quality up to 30 fps. As a true day/night camera, the FD8163 features a removable IR-cut filter and 15-meter smart IR illuminators, maintaining clear images 24 hours a day. It is especially suitable for monitoring wide open indoor areas such as a building lobby, train station, or applications requiring accurate identification.

For installers, properly adjusting the focus of a megapixel network camera can be difficult due to the image detail. Thus, VIVOTEK has introduced the Smart Focus System including Easy Focus Button and Remote Focus to make installation and adjustment easier. VIVOTEK has adopted lenses with a built-in stepper motor that the installer can use to remotely control the focal length and precisely adjust the camera focus, offering hassle-free installation and maintenance. Furthermore, the unique design featuring four-step mounting also facilitates installation of the FD8163.

Together with a PIR sensor for enhanced detection, WDR enhanced, 802.3af compliant PoE, tamper detection, microSD/SDHC/SDXC card slot for on-board storage, video cropping, and e-PTZ functionality, the FD8163 is indisputably the top choice for reliable and high performance surveillance.



## 1080p Resolution at Full Frame Rate

The VIVOTEK FD8163 is able to transmit 30 fps @ 1080p with H.264 compression, while conventional megapixel cameras generally only achieve 10 to 15 fps due to hardware limitations. The ability to view and record footage at a full frame rate enables much more effective surveillance.

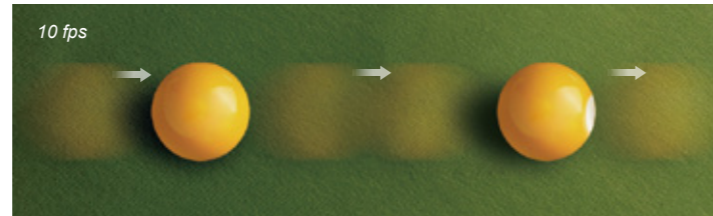
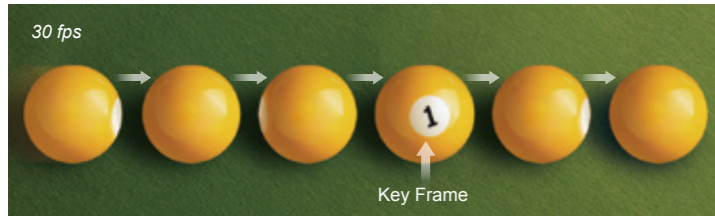

For example, if a person or object of interest passes quickly through the camera's field of view during an event, a 10 fps frame rate might mean only a single frame with the target is captured, while the FD8163 would capture three frames, providing a fuller record of the event and more reliable identification of the target.

## Wide Coverage, Exceptional Details

Compatible with the HDTV (16:9) standard, the FD8163 provides surveillance coverage for an area up to six times larger than possible with a VGA camera, significantly reducing the number of cameras required.



The FD8163 is especially well suited to monitor broad spaces such as shopping mall, airport, and hotel lobby, etc. In addition, it is excellent for applications requiring accurate recognition for post-content analysis, such as the identification of people or license plates.

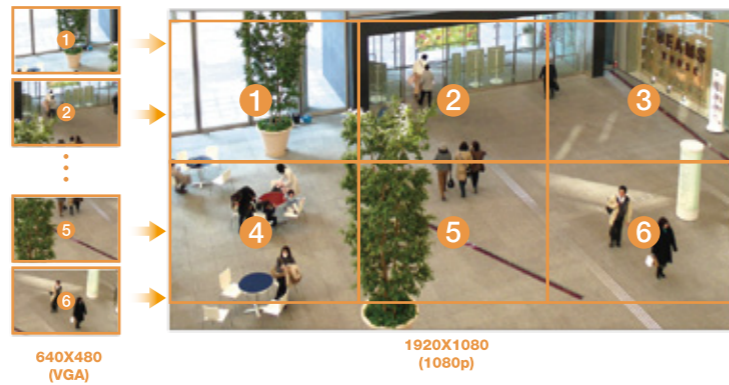

## Consistent Surveillance Performance

### • Adapted for High-contrast Lighting Conditions

When a camera is used in a high contrast, backlight, glare, or light reflective environment such as a building entrance, ATM, or window, a subject may appear dark and unrecognizable. WDR Enhanced technology compensates for the unbalanced lighting, restoring detail throughout the field of view, so as to give user unparalleled visibility to identify images.



### • Smart IR

When the Smart IR function is enabled, the camera automatically adjusts the IR lighting intensity in order to avoid overexposure in night mode and is highly beneficial in capturing usable video when the object of interest is close to the camera and IR LEDs.



## Smart Focus System

### • Remote Focus

To facilitate easier installation and adjustment, the FD8163 has adopted a lens with a built-in stepper motor that the installer can use to remotely control the focal length and precisely adjust the camera focus via the configuration webpage.

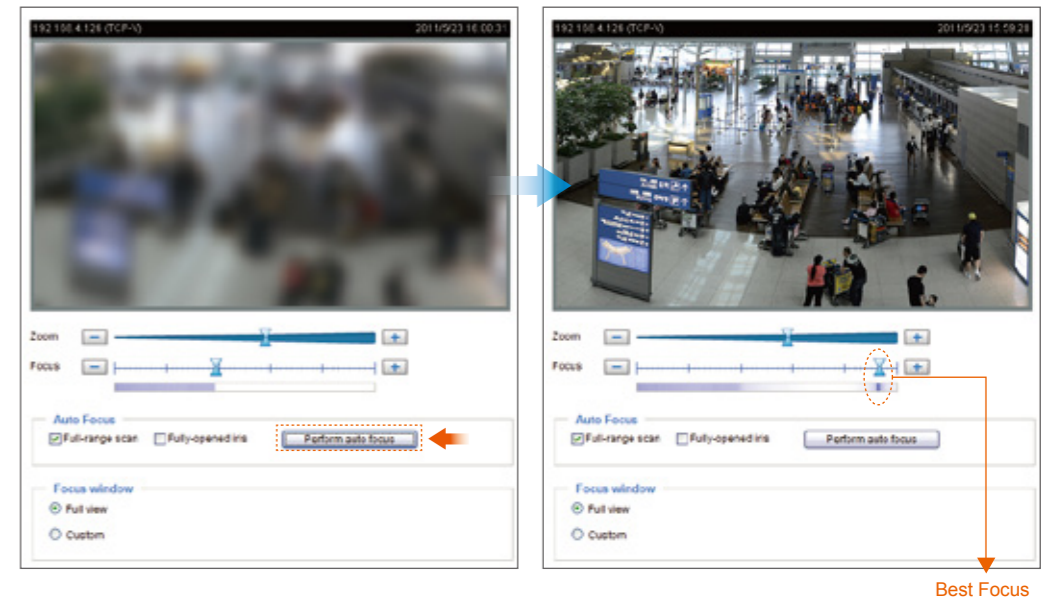

### • Easy Focus

The installer can also easily adjust the focus by pushing the auto focus button on camera body. The lens module will automatically adjust the focus to the best value, offering hassle-free installation and maintenance.

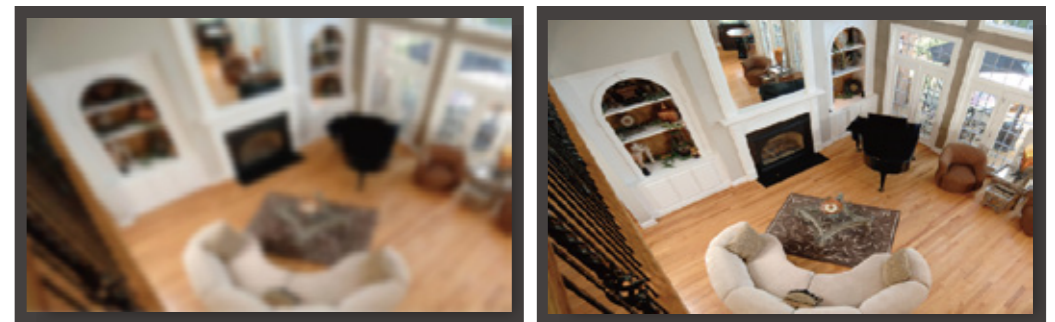
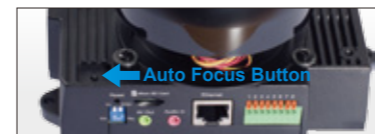

# FD8163 | Fixed Dome Network Camera

- 2-Megapixel CMOS Sensor
- 30 fps @ 1920x1080
- 3 ~ 9 mm Motorized, DC-iris Lens
- Removable IR-cut Filter for Day & Night Function
- Built-in IR Illuminators, Effective up to 15 Meters
- Built-in Smart IR to Avoid Overexposure
- Built-in PIR Sensor for Human Detection
- WDR Enhancement for Unparalleled Visibility in High Contrast Environments
- Real-time H.264, MPEG-4, and MJPEG Compression (Triple Codec)
- Smart Focus System for Remote and Easy Focus Adjustment
- Built-in 802.3af Compliant PoE
- Built-in MicroSD/SDHC/SDXC Card Slot for On-board Storage

