

XNV-6080RSA

2MP Network Stainless IR Dome Camera



Key Features

- Max. 2Megapixel (1920 x 1080) resolution
- 2.8 ~ 12mm (4.3x) motorized varifocal lens
- Max. 60fps@all resolutions (H.265 / H.264)
- H.265, H.264, MJPEG codec supported, Multiple streaming
- Day & Night (ICR), WDR (150dB), Defog
- Loitering, Directional detection, Tampering, Audio detection, Digital auto tracking, Fog detection, Sound classification
- Motion detection, Handover
- SD/SDHC/SDXC memory 2slots (Max. 512GB)
- Hallway view, WiseStream II support
- IR viewable length 50m
- IP66, IP6K9K, IK10+, NEMA4X
- LDC, PoE support

Accessories (Optional)



SBP-300HMS6



SBP-300WMS



SBP-300WMS1



SBP-300PMS

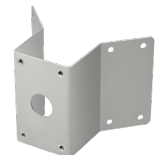

SBP-300KMS

Video	
Imaging Device	1/2.8"CMOS
Min. Illumination	Color: 0.015Lux(F1.4, 1/30sec) BW: 0Lux(IR LED on)
Video Out	CVBS: 1.0 Vp-p / 75Ω composite, 720x480(N), 720x576(P) for installation USB: Micro USB Type B, 1280x720 for installation
Lens	
Focal Length (Zoom Ratio)	2.8~12mm(4.3x) motorized varifocal
Max. Aperture Ratio	F1.4(Wide) ~ F3.6(Tele)
Angular Field of View	H: 119.5°(Wide)~27.9°(Tele) / V: 62.8°(Wide)~15.7°(Tele) / D: 142.1°(Wide)~32.0°(Tele)
Min. Object Distance	0.5m(1.64ft)
Focus Control	Simple focus
Lens Type	DC Auto Iris, P iris
Pan / Tilt / Rotate	
Pan / Tilt / Rotate Range	0°~354° / 0°~67° / 0°~355°
Operational	
Camera Title	Displayed up to 85 characters
Day & Night	Auto(ICR)
Backlight Compensation	BLC, HLC, WDR
Wide Dynamic Range	150dB
Digital Noise Reduction	SSNRV
Digital Image Stabilization	Support
Defog	Support
Motion Detection	8ea, 8point Polygonal zones
Privacy Masking	32ea, polygonal zones - Color : Gray, Green, Red, Blue, Black, White - Mosaic
Gain Control	Low / Middle / High
White Balance	ATW / AWC / Manual / Indoor / Outdoor
LDC	Support
Electronic Shutter Speed	Minimum / Maximum / Anti flicker (2~1/12,000sec)
Video Rotation	Flip, Mirror, Hallway view(90°/270°)
Analytics	Defocus detection, Directional detection, Fog detection, Face detection, Motion detection, Digital auto tracking, Appear/Disappear, Enter/Exit, Loitering, Tampering, Virtual line, Audio detection, Sound classification
Alarm I/O	Input 1ea / Output 1ea
Alarm Triggers	Analytics, Network disconnect, Alarm input
Alarm Events	File upload via FTP and e-mail Notification via e-mail SD/SDHC/SDXC or NAS recording at event triggers Alarm output Handover
Audio In	Selectable(mic in/line in) Supply voltage: 2.5VDC(4mA), Input impedance: 2K Ohm
Audio Out	Line out, Max.output level: 1Vrms

IR Viewable Length	50m(164.04ft)
Network	
Ethernet	RJ-45(10/100BASE-T)
Video Compression	H.265/H.264: Main/Baseline/High, MJPEG
Audio Compression	G.711 u-law /G.726 Selectable G.726(ADPCM) 8KHz, G.711 8KHz G.726: 16Kbps, 24Kbps, 32Kbps, 40Kbps AAC-LC: 48Kbps at 16KHz
Smart Codec	Manual(5ea area), WiseStreamII
Bitrate Control	H.264/H.265: CBR or VBR MJPEG: VBR
Streaming	Unicast(20 users) / Multicast Multiple streaming(Up to 10 profiles)
Protocol	IPv4, IPv6, TCP/IP, UDP/IP, RTP(UDP), RTP(TCP), RTCP, RTSP, NTP, HTTP, HTTPS, SSL/TLS, DHCP, FTP, SMTP, ICMP, IGMP, SNMPv1/v2c/v3(MIB-2), ARP, DNS, DDNS, QoS, PIM-SM, UPnP, Bonjour
Security	HTTPS(SSL) Login Authentication Digest Login Authentication IP Address Filtering User access Log 802.1X Authentication(EAP-TLS, EAP-LEAP)
Application Programming Interface	ONVIF Profile S/G/T SUNAPI(HTTP API) Wisenet open platform
Mechanical	
Color / Material	Silver / Stainless(SUS316L)
Product dimensions / weight	Ø162x120.5mm(Ø6.38x4.74") / 2.8kg(6.17lb)

- The latest product information / specification can be found at hanwha-security.com
- Design and specifications are subject to change without notice.
- Wisenet is the proprietary brand of Hanwha Techwin, formerly known as Samsung Techwin.

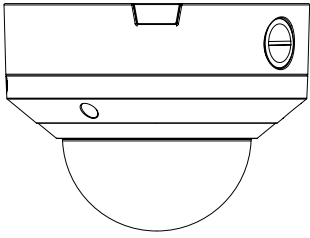
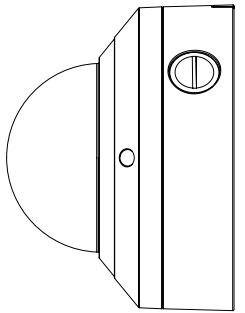

∅ 162 [6.38]

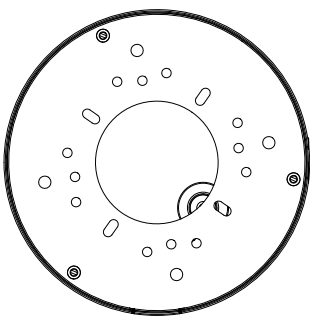
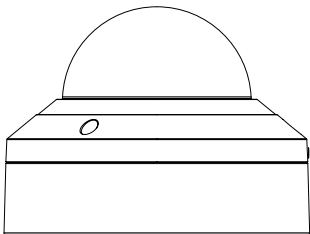
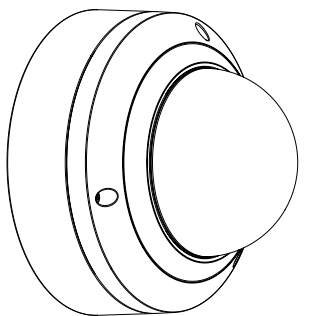
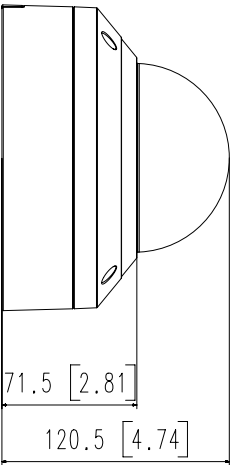
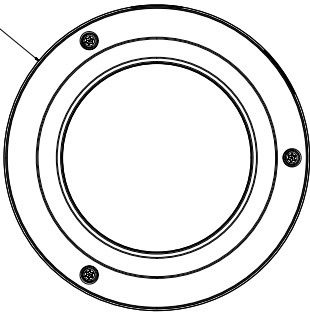

4	파셜 MODEL 3	XNV-8080R3A
3	파셜 MODEL 2	XNV-6080R2A
2	파셜 MODEL 1	XNV-8080R1A
1	BASIC MODEL	'18.05.08
No.	MODEL NAME	XNV-6080R1A