

antaira

LNP-1204G-10G-SFP

12-Port Industrial Gigabit PoE+ Unmanaged Ethernet Switch, w/8*10/100/1000Tx
(30W/Port), 2*1G SFP Slots, and 2*10G SFP+ Slots



Hardware Manual

Version 1.1
(November 2020)

antaira
www.antaira.com

© Copyright 2020 Antaira Technologies, LLC.

All Rights Reserved

This document contains information, which is protected by copyright. Reproduction, adaptation or translation without prior permission is prohibited, except as allowed under the copyright laws.

Trademark Information

Antaira is a registered trademark of Antaira Technologies, LLC., Microsoft Windows and the Windows logo are the trademarks of Microsoft Corp. NetWare is the registered trademark of Novell Inc. WMM and WPA are the registered trademarks of Wi-Fi Alliance. All other brand and product names are trademarks or registered trademarks of their respective owners.

Notice: Copyrights © 2020 by Antaira Technologies, LLC. All rights reserved. Reproduction, adaptation, or translation without prior permission of Antaira Technologies, LLC. is prohibited, except as allowed under the copyright laws.

Disclaimer

Antaira Technologies, LLC. provides this manual without warranty of any kind, expressed or implied, including but not limited to the implied warranties of merchantability and fitness for a particular purpose. Antaira Technologies, LLC. may make improvements and/or changes to the product and/or specifications of the product described in this manual, without prior notice. Antaira Technologies, LLC. will not be liable for any technical inaccuracies or typographical errors found in this guide. Changes are periodically made to the information contained herein and will be incorporated into later versions of the manual. The information contained is subject to change without prior notice.

FCC Warning

This equipment has been tested and found to comply with the limits for a Class-A digital device, pursuant to Part 15 of the FCC rules. These limits are designed to provide reasonable protection against harmful interference in a residential installation. This equipment generates, uses, and can radiate radio frequency energy. It may cause harmful interference to radio communications if the equipment is not installed and used in accordance with the instructions. However, there is no guarantee that interference will not occur in a particular installation. If this equipment does cause harmful interference to radio or television reception, which can be determined by turning the equipment off and on, the user is encouraged to try to correct the interference by one or more of the following measures:

- Reorient or relocate the receiving antenna.
- Increase the separation between the equipment and receiver.
- Connect the equipment into an outlet on a circuit different from that to which the receiver is connected.
- Consult the dealer or an experienced radio/TV technician for help.

Caution: Any changes or modifications not expressly approved by the grantee of this device could void the user's authority to operate the equipment.

Avertissement FCC

Cet équipement a été testé et déclaré conforme aux limites d'un appareil numérique de classe A, conformément à la partie 15 des règles de la FCC. Ces limites sont conçues pour fournir une protection raisonnable contre les interférences nuisibles dans une installation résidentielle. Cet équipement génère, utilise et peut émettre de l'énergie radiofréquence. Cela peut provoquer des interférences nuisibles aux communications radio si l'équipement n'est pas installé et utilisé conformément aux instructions. Cependant, il n'y a aucune garantie qu'aucune interférence ne se produira dans une installation particulière. Si cet équipement provoque des interférences nuisibles à la réception radio ou télévision, ce qui peut être déterminé en éteignant puis en rallumant l'équipement, l'utilisateur est encouragé à essayer de corriger les interférences par une ou plusieurs des mesures suivantes:

- Réorientez ou déplacez l'antenne de réception.
- Augmentez la distance entre l'équipement et le récepteur.
- Connectez l'équipement à une prise sur un circuit différent de celui auquel le récepteur est connecté.
- Consultez le revendeur ou un technicien radio / TV expérimenté pour obtenir de l'aide.

Attention: Tout changement ou modification non expressément approuvé par le bénéficiaire de cet appareil peut annuler le droit de l'utilisateur à utiliser l'équipement.

CE Mark Warning

This is a Class-A product. In a domestic environment this product may cause radio interference in which case the user may be required to take adequate measures.

Avertissement de marque CE

Ceci est un produit de classe A. Dans un environnement domestique, ce produit peut provoquer des interférences radio, auquel cas l'utilisateur peut être amené à prendre des mesures adéquates.

Industrial Ethernet Switches

Industrial Grade Gigabit Unmanaged Ethernet Switches

Hardware Manual

Version 1.1 (November 2020)

This manual supports the following models:

- LNP-1204G-10G-SFP

Table of Contents

1. Introduction	6
1.1 Product Overview	6
1.2 Product Hardware Features	6
1.3 Package Contents	7
1.4 Safety Precaution	7
2. Hardware Description	8
2.1 Physical Dimensions	8
2.2 Front Panel	9
2.3 Top View	9
2.4 LED Indicators	10
2.5 Ethernet Ports	10
2.6 Cabling	11
2.7 Wiring the Power Inputs	12
2.8 Wiring the Fault Alarm Contact	13
2.9 Grounding Note	13
3. Mounting Installation	15
3.1 DIN-Rail Mounting	15
3.2 Wall Mounting	16
4. Hardware Installation	17
4.1 Installation Steps	17
4.2 Maintenance and Service	18
4.3 Troubleshooting	18
5. Technical Specifications	19

1. Introduction

1.1 Product Overview

Antaira Technologies' LNP-1204G-10G-SFP are industrial gigabit PoE+ unmanaged Ethernet switches featuring 8*10/100/1000Tx Gigabit Ethernet ports that support IEEE802.3at for a maximum of 30W/port. The LNP-1204G-10G-SFP has 2*1G SFP slots and 2*10G SFP+ slots that provide options for long-distance fiber connections. These Ethernet switches are designed with high EFT and ESD protection and support standard operating temperatures from -40° to 65°C.

The LNP-1204G-10G-SFP are IP30 rated and DIN-rail mountable. They also provide Ethernet connectivity with PoE functions for outdoor or harsh industrial automation application environments, such as security surveillance, ITS-traffic monitoring systems, oil/gas and mining, facility management for power/utility, water wastewater treatment plants, and lastly, automated production lines in factory automation.

1.2 Product Hardware Features

- System Interface and Performance
 - All RJ45 ports support Auto MDI/MDI-X Function
 - Embedded 8*10/100/1000Tx (PSE: 30W/Port) RJ45 ports, 2*1G SFP slots, and 2*10G SFP+ slots
 - Store-and-forward switching architecture
 - 16K MAC address table
 - Supports 9.6Kbytes Jumbo Frame
 - 8Mbits memory buffer
- Power Input
 - DC 48~55V redundant, with a 6-pin removal terminal block, with SELV output certified by UL61010-2-201
 - It is recommended to use a UL listed industrial power supply
 - 1 removable 6-contact terminal block
 - Max. current 5.23A
 - Max. PoE output: 240W
- Operating Temperature
 - Standard operating temperature model: -40°C to 65°C
- Case/Installation
 - IP30 protection
 - DIN-Rail and wall mount design

- Installation in pollution degree 2 environment

1.3 Package Contents

- 1 – LNP-1204G-10G-SFP
- 1 – Quick Installation Guide
- 1 – Wall mounting bracket set with screws
- 1 – DC cable – 18 AWG & DC jack 5.5 x 2.1mm

1.4 Safety Precaution

Attention: If the DC voltage is supplied by an external circuit, please use a protection device on the power supply input. The industrial Ethernet switch's hardware specs, ports, cabling information, and wiring installation will be described within this user manual.

Attention: Si la tension CC est fournie par un circuit externe, veuillez utiliser un dispositif de protection sur l'entrée d'alimentation. Les spécifications matérielles, les ports, les informations de câblage et l'installation du câblage du commutateur Ethernet industriel seront décrits dans ce manuel d'utilisation.

Warning Labels

The caution label means that you should check the certain information on user manual when working with the device. (Shown in Figure 1.1)

Étiquettes d'avertissement

L'étiquette d'avertissement signifie que vous devez vérifier certaines informations sur le manuel d'utilisation lorsque vous travaillez avec l'appareil. (Montré dans la figure 1.1)



Figure 1.1 - Caution Label
Figure 1.1 - Étiquette de mise en garde



Figure 1.2 - Hot Surface Warning Label
Figure 1.2 - Étiquette d'avertissement de surface chaude

2. Hardware Description

2.1 Physical Dimensions

Figure 2.1, below, shows the physical dimensions of Antaira's LNP-1204G-10G-SFP:

(W x D x H) is 54mm x 99mm x 142mm

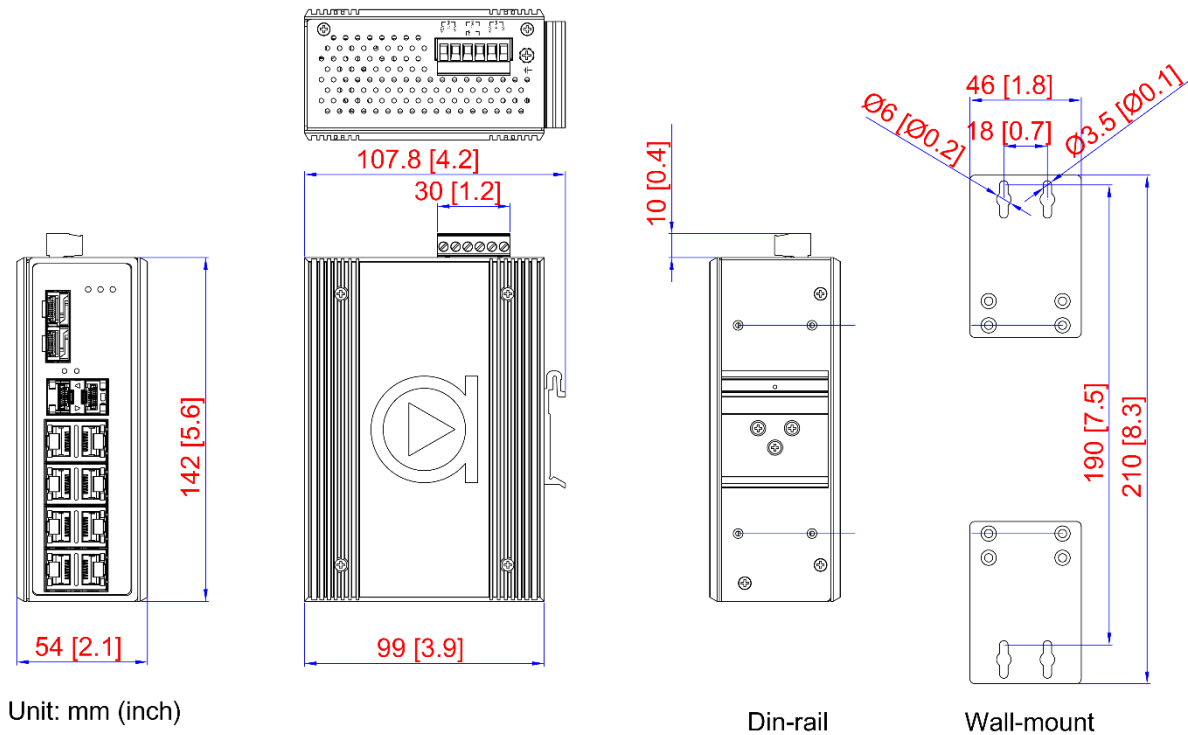

Figure 2.1

LNP-1204G-10G-SFP Physical Dimensions

2.2 Front Panel

The front panel of the LNP-1204G-10G-SFP industrial gigabit unmanaged Ethernet switch is shown below in *Figure 2.2*.

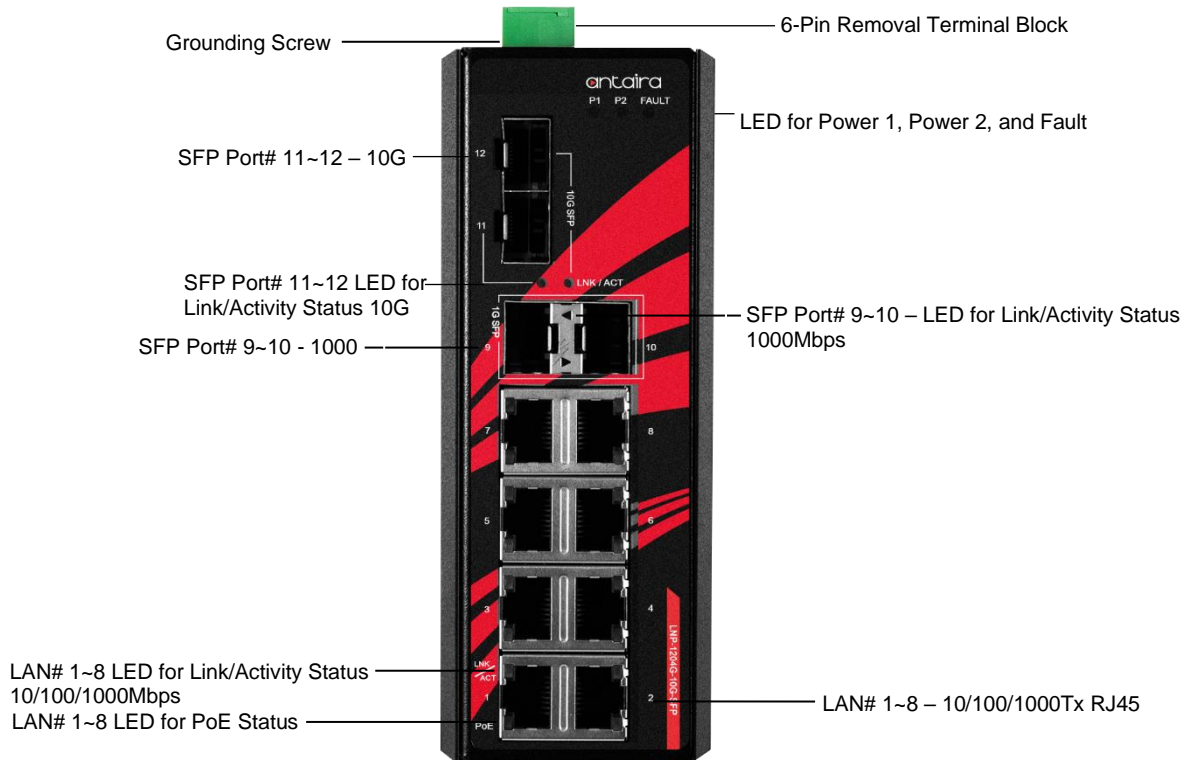

Figure 2.2 - The Front Panel of LNP-1204G-10G-SFP

2.3 Top View

Figure 2.3, below, shows the top panel of the LNP-1204G-10G-SFP switch that is equipped with one 6-pin removal terminal block connector for dual DC power inputs (48~55VDC).

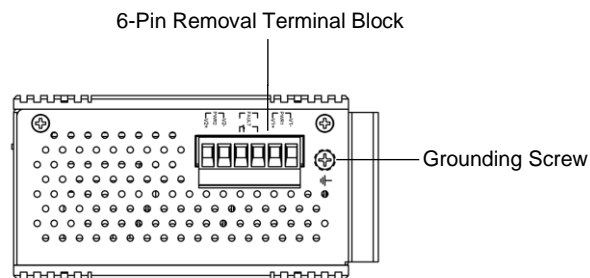

Figure 2.3

Top Panel View of LNP-1204G-10G-SFP

2.4 LED Indicators

There are LED light indicators located on the front panel of the industrial Ethernet switch that display the power status and network status. Each LED indicator has a different color and has its own specific meaning, see below in *Table 2.1*.

LED	Color	Description	
P1	Green	On	Power input 1 is active
		Off	Power input 1 is inactive
P2	Green	On	Power input 2 is active
		Off	Power input 2 is inactive
Fault	Red	On	Power input 1 or 2 is inactive
		Off	Power input 1 and 2 is active
LAN Port 1~8 (Upper LED)		On	Connected to network, 10/100/1000Mbps
		Flashing	Networking is active
		Off	Not connected to network
LAN Port 1~8 (Lower LED)		On	Supplying power to the powered-device
		Off	Not connected to a powered-device
		Green	
SFP Port 9~10	Green	On	Connected to network, 1000Mbps
		Flashing	Networking is active
		Off	Not connected to network
SFP+ Port 11~12	Green	On	Connected to network, 10Gbps
		Flashing	Networking is active
		Off	Not connected to network

Table 2.1 - LED Indicators for LNP-1204G-10G-SFP

Note: "P1" is the abbreviation for "Power 1", "P2" is for "Power 2", "LNK" is for "Link", and "ACT" is for "Activity".

2.5 Ethernet Ports

- **RJ-45 Ports**

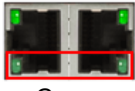
RJ-45 Ports (Auto MDI/MDIX): The RJ-45 ports are auto-sensing for 10Base-T, 100Base-TX, or 1000Base-T connections. Auto MDI means that the switch can connect to another switch or workstation without changing the straight-through or crossover cabling. See the figures below for straight-through and crossover cabling schematics.

- **RJ-45 Pin Assignments**

Pin Number	Assignment
1	Rx+
2	Rx-
3	Tx+
6	Tx-

Table 2.3 - RJ45 Pin Assignments

Note: The “+” and “-” signs represent the polarity of the wires that make up each wire pair.

All ports on this industrial Ethernet switch support automatic MDI operations. Users can use straight-through cables (see figure below) for all network connections to PCs, servers, and other switches or hubs. With straight-through cabling, pins 1, 2, 3, and 6 are at one end of the cable and are connected straight through to pins 1, 2, 3 and 6 at the other end of the cable. The table below (Table 2.4) shows the 10BASE-T/100BASE-TX/1000BASE-T MDI port pin outs.

Pin MDI-X	Signal Name	MDI Signal Name
1	Receive Data plus (RD+)	Transmit Data plus (TD+)
2	Receive Data minus (RD-)	Transmit Data minus (TD-)
3	Transmit Data plus (TD+)	Receive Data plus (RD+)
6	Transmit Data minus (TD-)	Receive Data minus (RD-)

Table 2.4 - Ethernet Signal Pin

The following figures show the cabling schematics for straight-through and crossover.

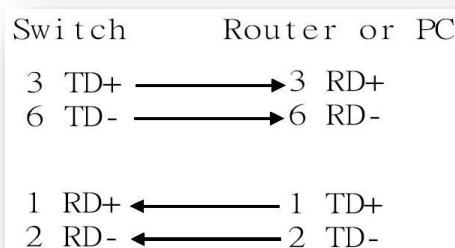

Figure 2.4 - Straight-Through Cables Schematic

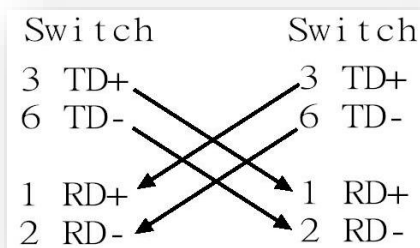

Figure 2.5 - Crossover Cables Schematic

2.6 Cabling

Use the four twisted-pair, category 5e, or the above cabling for the RJ-45 port connections. The cable between the switch and the link partner (switch, hub, workstation, etc.) must be less than 100 meters

(328 ft.) in length.

The small form-factor pluggable (SFP) is a compact optical transceiver used in optical communications for both telecommunication and data communication applications.



Caution: Please employ optional optical transceiver (SFP/Fixed Fiber) that complies with IEC-60825-1 and classified as Class 1 laser product.



Attention: Veuillez utiliser un émetteur-récepteur optique en option (SFP/fibre fixe) conforme à la norme IEC-60825-1 et classé comme produit laser de classe 1.

2.7 Wiring the Power Inputs



Caution: Please follow the steps below when inserting the power wire.



Attention: Veuillez suivre les étapes ci-dessous lors de l'insertion du câble d'alimentation.

1. Insert the positive and negative wires into the PWR1 (V1+, V1-) and PWR2 (V2+, V2-) contacts on the terminal block connector as shown below in *Figure 2.6*.

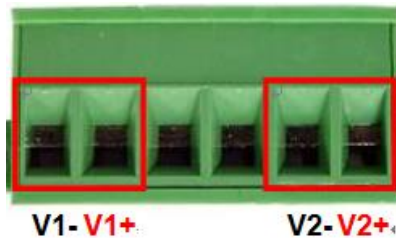

Figure 2.6
Power Terminal Block

2. Tighten the wire-clamp screws to prevent the wires from loosening, as shown below in *Figure 2.7*.



Figure 2.7
Power Terminal Block



Caution:

Only use copper conductors, **125°C**, tighten to **5 lbs.**

The wire gauge for the terminal block should range between **18-20 AWG**.



Attention:

Utilisez uniquement des conducteurs en cuivre, **125°C**, serrez à **5 lb.**

Le calibre des fils du bornier doit être compris entre **18 et 20 AWG**.

2.8 Wiring the Fault Alarm Contact

The fault alarm contact is in the middle of the terminal block connector as the picture shows below in *Figure 2.8*. By inserting the wires, it will detect the fault status including power failure or port link failure (managed industrial switch only) and form a normal open circuit. An example is shown below in *Figure 2.8*.

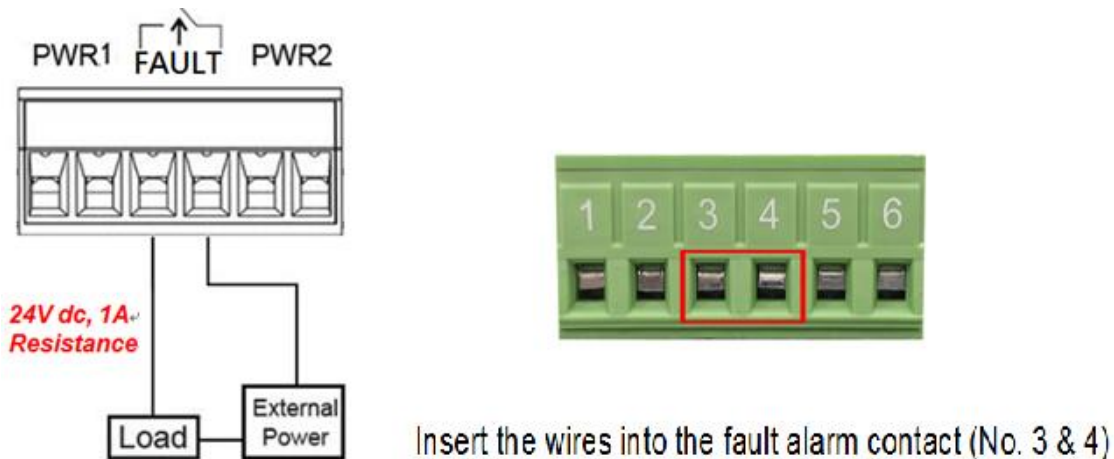

Figure 2.8
Wiring the Fault Alarm Contact



Caution:

- The wire gauge for the terminal block should range between 12 ~ 24 AWG.
- If only using one power source, jumper Pin 1 to Pin 5 and Pin 2 to Pin 6 to eliminate power fault alarm.



Attention:

- Le calibre des fils du bornier doit être compris entre 12 et 24 AWG.
- Si vous n'utilisez qu'une seule source d'alimentation, connectez les broches 1 à 5 et les broches 2 à 6 pour éliminer l'alarme de panne de courant.

2.9 Grounding Note

Grounding and wire routing help limit the effects of noise due to Electromagnetic Interference

(EMI). Run the ground connection from the ground screw to the grounding surface prior to connecting devices. The grounding screw symbol is shown below in *Figure 2.9*.



Figure 2.9 - Grounding screw symbol



Caution: Using a shielded cable achieves better electromagnetic compatibility.



Attention: L'utilisation d'un câble blindé permet une meilleure compatibilité électromagnétique.

3. Mounting Installation

3.1 DIN-Rail Mounting

The DIN-Rail is pre-installed on the industrial Ethernet switch from the factory. If the DIN-Rail is not on the industrial Ethernet switch, please see *Figure 3.1* to learn how to install the DIN-Rail on the switch.

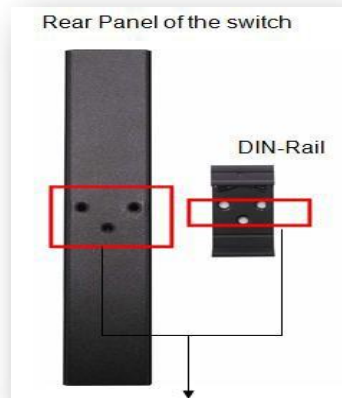

Figure 3.1

The Rear Side of the Switch and DIN-Rail

Follow the steps below to learn how to hang the industrial Ethernet switch.

1. Use the screws to install the DIN-Rail bracket on the rear side of the industrial Ethernet switch.



Caution: The torque for tightening the screws on the device is 3.5 in-lbs.



Attention: Le couple de serrage des vis sur l'appareil est de 3.5 pouces-livres.

2. To remove the DIN-Rail bracket, do the opposite from step 1.
3. After the DIN-Rail bracket is installed on the rear side of the switch, insert the top of the DIN-Rail on to the track as shown below in *Figure 3.2*.
4. Lightly pull down the bracket on to the rail as shown below in *Figure 3.3*.
5. Check if the bracket is mounted tightly on the rail.
6. To remove the industrial Ethernet switch from the rail, do the opposite from the above steps.



Figure 3.2

Insert the Switch on the DIN-Rail

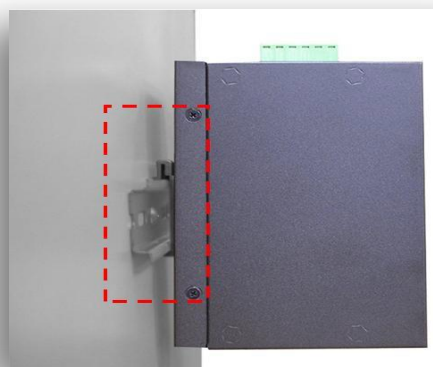

Figure 3.3

Stable the Switch on DIN-Rail

3.2 Wall Mounting

Follow the steps below to mount the industrial Ethernet switch using the wall mounting bracket as shown below in *Figure 3.4*.



Caution: "Wall" means industrial control panel wall



Attention: "Wall" signifie mur de panneau de commande industriel

1. Remove the DIN-Rail bracket from the industrial Ethernet switch by loosening the screws.
2. Place the wall mounting brackets on the top and bottom of the industrial Ethernet switch.
3. Use the screws to screw the wall mounting bracket on the industrial Ethernet switch.



Caution: The torque for tightening the screws on the device is 3.5 in-lbs.



Attention: Le couple de serrage des vis sur l'appareil est de 3.5 pouces-livres.

4. Use the hook holes at the corners of the wall mounting bracket to hang the industrial Ethernet switch on the wall.
5. To remove the wall mount bracket, do the opposite from the steps above.

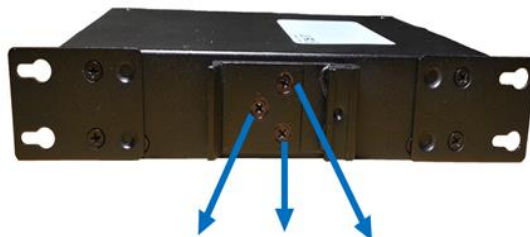

Figure 3.4

Remove DIN-Rail Bracket from the Switch

Below, in *Figure 3.5* are the dimensions of the wall mounting bracket.

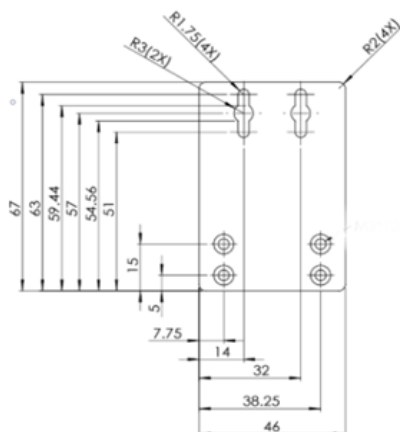

Figure 3.5

Wall Mounting Bracket Dimensions

4. Hardware Installation

4.1 Installation Steps

This section will explain how to install Antaira's LNP-1204G-10G-SFP:



Caution: This device is intended for use indoor.



Attention: Cet appareil est destiné à être utilisé à l'intérieur.



Caution: The device is intended to be installed in an industrial control enclosure and panel.



Attention: L'appareil est destiné à être installé dans une armoire de commande et un panneau industriels.

Installation Steps

1. Unpack the industrial Ethernet switch from the original packing box.
2. Check if the DIN-Rail bracket is screwed on the industrial Ethernet switch.
 - If the DIN-Rail is not screwed on the industrial Ethernet switch, please refer to the **DIN-Rail Mounting** section for DIN-Rail installation.
 - If you want to wall mount the industrial Ethernet switch, please refer to the **Wall Mounting** section for wall mounting installation.
3. To hang the industrial Ethernet switch on a DIN-Rail or wall, please refer to the **Mounting Installation** section.
4. Power on the industrial Ethernet switch and then the power LED light will turn on.
 - If you need help on how to wire power, please refer to the **Wiring the Power Inputs** section.
 - Please refer to the **LED Indicators** section for LED light indication.
5. Prepare the twisted-pair, straight-through category 5 cable for Ethernet connection.
6. Insert one side of the RJ-45 cable into switch's Ethernet port and on the other side into the networking device's Ethernet port, e.g. switch PC or server. The Ethernet port's (RJ-45) LED on the industrial Ethernet switch will turn on when the cable is connected to the networking device.
 - Please refer to the **LED Indicators** section for LED light indication.
7. When all connections are set and the LED lights all show normal, the installation is complete.

4.2 Maintenance and Service

- If the device requires servicing of any kind, the user is required to disconnect and remove it from its mounting. The initial installation should be done in a way that makes this as convenient as possible.
- Voltage/Power lines should be properly insulated as well as other cables. Be careful when handling them so as to not trip over.
- Do not under any circumstance insert foreign objects of any kind into the heat dissipation holes located in the different faces of the device. This may not only harm the internal layout, but might cause harm to user as well.
- Do not under any circumstance open the device for any reason. Please contact your dealer for any repair needed or follow the instructions within the manual.
- Clean the device with dry soft cloth.

4.3 Troubleshooting

- Verify the right power cord/adaptor, never use power supply/adaptor with noncompliant DC output voltage, or it will burn the equipment.
- Select the proper UTP/STP cable to construct the network with using the right cable. Use unshielded twisted-pair (UTP) or shield twisted-pair (STP) cable for RJ-45 connections: 100Ω Category 5e/above cable for 10M/100Mbps. Also be sure that the length of any twisted-pair connection does not exceed 100 meters (328 feet).
- Diagnosing LED Indicators: To assist in identifying problems, the Switch can be easily monitored through LED indicators, which describe common problems a user may encounter and where the user can find possible solutions.
- If the power indicator LED does not turn on when the power cord is plugged in, the user may have a problem with the power cord. Check for loose power connections, power losses or surges at the power outlet. Please contact Antaira or Antaira's authorized channel partners for technical support service, if the problem still cannot be resolved.
- If the Industrial switch LED indicators are normal and the connected cables are correct but the packets still cannot transmit. Please check the system's Ethernet devices' configuration or status.

5. Technical Specifications

Table 5.1 has the technical specifications for Antaira's LNP-1204G-10G-SFP:

Technology	Standards	IEEE 802.3 10Tx Ethernet IEEE 802.3u 100Tx Fast Ethernet IEEE 802.3ab 1000Tx Gigabit Ethernet IEEE 802.3z 1000X Gigabit Fiber IEEE 802.3ae 10 Gigabit Ethernet IEEE 802.3af/at Power over Ethernet IEEE 802.3x Flow Control
	Processing Type	Store and Forward
	Protocol	CSMA/CD
	Flow Control	IEEE 802.3x flow control, back pressure flow control
Switch Properties	Back-Plane (Switching Fabric)	60Gbps
	Transfer Rate	14,880pps for Ethernet Port 148,800pps for Fast Ethernet Port 1,488,000pps for Gigabit Ethernet Port 14,880,000pps for 10 Gigabit Ethernet Port
	Memory Buffer	8Mbits
	Jumbo Frame	9.6Kbytes
	MAC Table Size	16K
Port Interface	Ethernet Port	8*10/100/1000Base-TX, auto negotiation speed, Full/Half duplex mode, and auto MDI/MDI-X connection
	PoE Pin Out	V+, V+, V-, V-, for pin 1, 2, 3, 6 (End-span, Mode A)
	SFP Port	2*1000 SFP slots 2*10G SFP+ slots
	Wavelength	Depends on SFP modules
	Relay Contact	24VDC, 1A resistive
	Network Cable	10Base-T: 2-pair UTP/STP Cat. 3, 4, 5 cable EIA/TIA-568 100-ohm (100m) 100Base-TX: 2-pair UTP/STP Cat. 5 cable EIA/TIA-568 100-ohm (100m) 1000Base-TX: 4-pair UTP/STP Cat.5/5E cable; EIA/TIA-568 100-ohm (100m)
Mechanical Characteristics	Housing	Metal, IP30 protection
	Dimensions	54 x 142 x 99 mm (W x H x D)
	Weight	Unit: 2.52 lbs Shipping: 3.13 lbs
	Mounting	DIN-Rail, Wall-mounting
Power Requirement	Input Voltage	48–55VDC Redundant Input
	Power Connection	1 removable 6-contact terminal block
	Overload Current Protection	Present
	Reverse Polarity	Present

	Protection	
	PoE Power Output	30W max. per PoE port
	PoE Power Budget	240W
	System Power Consumption	10.7W
Environment Limits	Operating Temperature	-40°C to 65°C
	Storage Temperature	-40°C to 85°C
	Ambient Relative Humidity	5% to 95%, (non-condensing)
Regulatory Approvals	EMI	FCC Part 15 Subpart B Class A, CE EN55032/EN61000-6-4 Class A
	EMS	CE EN55035/EN61000-6-2 Class A, IEC61000-4-2,3,4,5,6,8
	Free Fall	IEC60068-2-32
	Shock	IEC60068-2-27
	Vibration	IEC60068-2-6
	Green	RoHS Compliant
	Certifications	FCC, CE, UL 61010-1, 61010-2-201
	Warranty	5 Years

Table 5.1 - LNP-1204G-10G-SFP Technical Specifications

Antaira Customer Service and Support

(Antaira US Headquarter) + 844-268-2472

(Antaira Europe Office) + 48-22-862-88-81

(Antaira Asia Office) + 886-2-2218-9733

Please report any problems to Antaira:

www.antaira.com / support@antaira.com

www.antaira.eu / info@antaira.eu

www.antaira.com.tw / info@antaira.com.tw

Any changes to this material will be announced on the Antaira website.