



LNP-1802G-SFP Series

**18-Port Industrial Gigabit PoE+ Unmanaged Ethernet Switch,
with 16*10/100/1000Tx (PSE: 30W/Port) + 2*100/1000 SFP Slots**



Version 1.0

User Manual



www.antaira.com

© Copyright 2018 Antaira Technologies, LLC.

All Rights Reserved

This document contains information, which is protected by copyright. Reproduction, adaptation or translation without prior permission is prohibited, except as allowed under the copyright laws.

Trademark Information

Antaira is a registered trademark of Antaira Technologies, LLC, Microsoft Windows and the Windows logo are the trademarks of Microsoft Corp. NetWare is the registered trademark of Novell Inc. WMM and WPA are the registered trademarks of Wi-Fi Alliance. All other brand and product names are trademarks or registered trademarks of their respective owners.

Notice: Copyrights © 2018 by Antaira Technologies, LLC. All rights reserved. Reproduction, adaptation, or translation without prior permission of Antaira Technologies, LLC. is prohibited, except as allowed under the copyright laws.

Disclaimer

Antaira Technologies, LLC. provides this manual without warranty of any kind, expressed or implied, including but not limited to the implied warranties of merchantability and fitness for a particular purpose. Antaira Technologies, LLC. may make improvements and/or changes to the product and/or specifications of the product described in this manual, without prior notice. Antaira Technologies, LLC. will not be liable for any technical inaccuracies or typographical errors found in this guide. Changes are periodically made to the information contained herein and will be incorporated into later versions of the manual. The information contained is subject to change without prior notice.

FCC Notice

This equipment has been tested and found to comply with the limits for a Class-A digital device, pursuant to Part 15 of the FCC rules. These limits are designed to provide reasonable protection against harmful interference in a residential installation. This equipment generates, uses, and can radiate radio frequency energy. It may cause harmful interference to radio communications if the equipment is not installed and used in accordance with the instructions. However, there is no guarantee that interference will not occur in a particular installation. If this equipment does cause harmful interference to radio or television reception, which can be determined by turning the equipment off and on, the user is encouraged to try to correct the interference by one or more of the following measures:

- Reorient or relocate the receiving antenna.
- Increase the separation between the equipment and receiver.
- Connect the equipment into an outlet on a circuit different from that to which the receiver is connected.
- Consult the dealer or an experienced radio/TV technician for help.

Caution: Any changes or modifications not expressly approved by the grantee of this device could void the user's authority to operate the equipment.

CE Mark Warning

This is a Class-A product. In a domestic environment this product may cause radio interference in which case the user may be required to take adequate measures.

Industrial Ethernet Switches

Industrial Grade Unmanaged Ethernet Switches

User Manual

Version 1.0 (October 2018)

This manual supports the following models:

- LNP-1802G-SFP
- LNP-1802G-SFP-T

This document is the current official release manual. Please check our website (www.antaira.com) for any updated manual or contact us by e-mail (support@antaira.com).

Table of Contents

1. Overview	1
1.1 Key Features.....	1
1.2 Package Contents.....	2
1.3 Safety Precaution.....	2
2. Hardware Description	3
2.1 Physical Dimensions	3
2.2 Front Panel	4
2.3 Top View	4
2.4 LED Indicators	5
2.5 Ethernet Ports	6
2.6 Cabling	7
2.7 Wiring the Power Inputs.....	9
2.8 Wiring the Fault Alarm Contact	9
3. Mounting Installation	10
3.1 DIN-Rail Mounting.....	10
3.2 Wall Mounting	11
4. Hardware Installation	12
4.1 Installation Steps.....	12
5. Network Applications.....	13
6. Troubleshooting.....	14
7. Technical Specifications	15

1. Overview

Antaira Technologies' LNP-1802G-SFP series is an 18-port industrial grade gigabit Ethernet unmanaged switch. This rugged switch is enclosed in a metal IP30 rated design with 16*10/100/1000 RJ45 Ethernet ports that are IEEE 802.3af/at compliant (Power over Ethernet) and 2*100/1000 dual rate SFP slots. This series is the perfect solution for any application requiring high bandwidth and long-distance communication, and high density PoE connectivity.

The LNP-1802G-SFP series is a power sourcing device that supports PoE+ when an input voltage power of 48~55VDC range is applied. This product series supports high EFT & ESD protection to prevent damage from unregulated power coming into the unit. It has built-in redundant power inputs that support reverse polarity and overload current protection. It supports DIN-Rail as well as wall mountable orientations and provides wide operating temperature range models in STD: -10°C to 65°C and EOT: -40°C to 75°C. This is an industrial grade unit made for any harsh or outdoor networking environment in factory automation, ITS, power/utility, and water wastewater treatment plants. This unit is also ideal for any other application requiring a high port count solution.

1.1 Key Features

- System Interface/Performance
 - All RJ-45 ports support the auto MDI/MDI-X function
 - Ethernet connectivity 16*10/100/1000Tx RJ45 ports (PSE: 30W/Port)
 - Fiber connectivity with 2*100/1000 Dual rate SFP slots
 - Store-and-forward switching architecture
 - 8K MAC address table
 - Jumbo frame supports up to 9,216bytes
 - 512Kbytes memory buffer
- Power Input
 - DC 48~55V redundant power, with a 6-pin removal terminal block
- Operating Temperature
 - Standard operating temperature model: -10°C ~ 65°C
 - Extended operating temperature model (-T): -40°C ~ 75°C
- Case/Installation
 - IP-30 protection
 - DIN-Rail and wall mount design

1.2 Package Contents

- 1 – LNP-1802G-SFP(-T)
- 1 – Quick Installation Guide
- 2 – Wall mounting brackets and screws
- 1 – DC cable –18 AWG & DC jack 5.5 x 2.1mm

1.3 Safety Precaution

Attention: If the DC voltage is supplied by an external circuit, please use a protection device on the power supply input. The industrial Ethernet switch's hardware specs, ports, cabling information, and wiring installation will be described within this user manual.

2. Hardware Description

2.1 Physical Dimensions

Figure 2.1, below, shows the physical dimensions of Antaira Technologies' LNP-1802G-SFP series.

(W x D x H) is 67mm x 99mm x 142mm

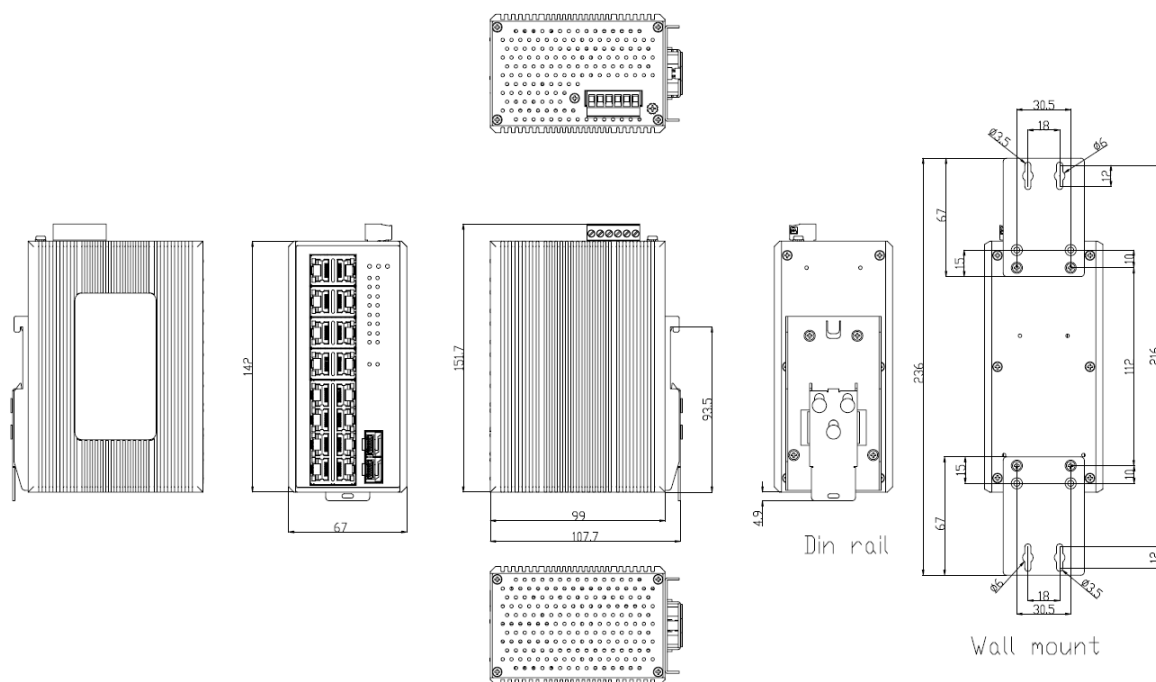

Figure 2.1

2.2 Front Panel

See *Figure 2.2* for the front panel of the LNP-1802G-SFP series.

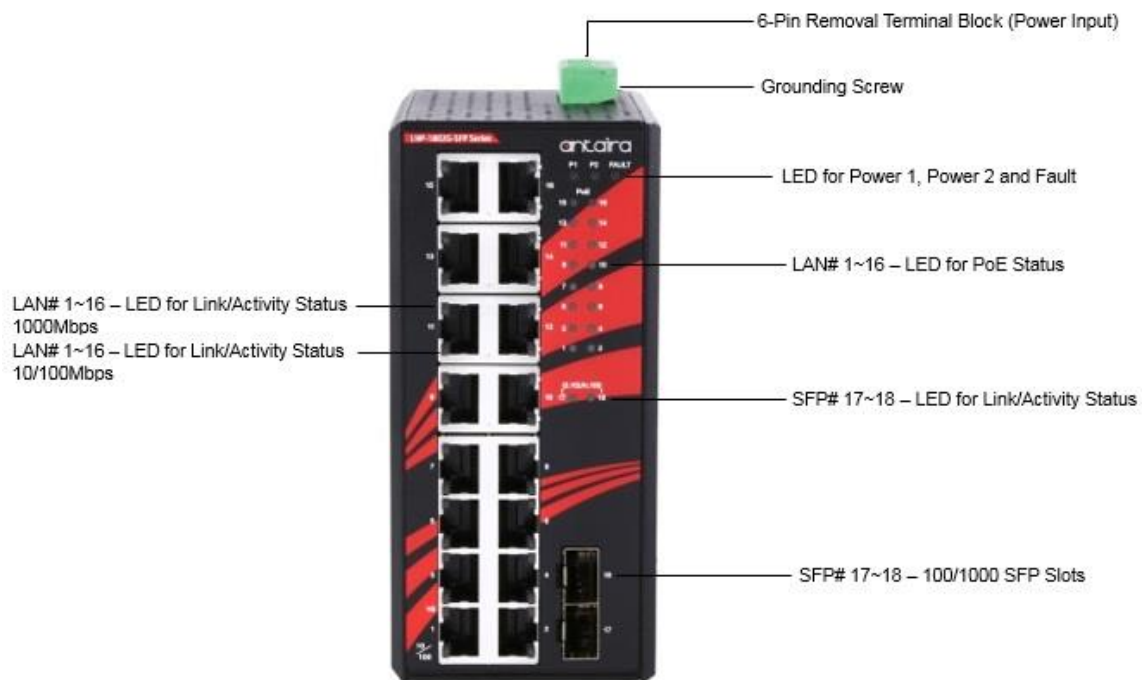

Figure 2.2

2.3 Top View

Figure 2.3, below, shows the top panel of the LNP-1802G-SFP series switch that is equipped with one 6-pin removal terminal block connector for dual DC power inputs (48-55 VDC).

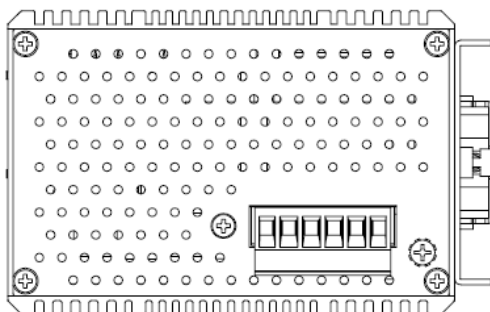

Figure 2.3

2.4 LED Indicators

There are LED light indicators located on the front panel of the industrial Ethernet switch that display the power status and network status. Each LED indicator has a different color and has its own specific meaning, see below in *Table 2.1*.



LED	Color	Description	
Power 1	Green	On	Power input 1 is active
		Off	Power input is inactive
Power 2	Green	On	Power input 2 is active
		Off	Power input is inactive
Fault	Red	On	Power input 1 or 2 is inactive
		Off	Both power input 1 and 2 are active
SFP Port LINK/ACT (Port 17~18)	Green	On	Connected to the network - 1000Mbps
		Flashing	Networking is active
		Off	Not connected to the network
	Amber	On	Connected to the network - 100Mbps
		Flashing	Networking is active
		Off	Not connected to the network
LAN Port (Port 1~16)	 Green	On	Connected to network - 1000Mbps
		Flashing	Networking is active
		Off	Not connected to network
	 Green	On	Connected to network - 10/100Mbps
		Flashing	Networking is active
		Off	Not connected to network
PoE Indicator (Port 1~16)	Green	On	The port is supplying power to the powered-device
		Off	No powered-device attached or power supplying fails

Table 2.1

Note: “P1/P2” is the abbreviation for “Power 1/Power 2”, “LNK” is for “Link”, and “ACT” is for “Activity”.

2.5 Ethernet Ports

■ RJ-45 Ports (Auto MDI/MDIX):

The RJ-45 ports are auto-sensing for 10/100/1000Base-Tx devices connections. Auto MDI/MDIX means that the switch can connect to another switch or workstation without changing the straight-through or crossover cabling. See the figures shown below for straight-through and crossover cabling schematics.

■ RJ-45 Pin Assignments (Table 2.2)

Pin Number	Assignment
1	Rx+
2	Rx-
3	Tx+
6	Tx-

Table 2.2
RJ45 Pin Assignments

Note: The “+” and “-” signs represent the polarity of the wires that make up each wire pair.

All ports on this industrial Ethernet switch support automatic MDI/MDI-X operations. Users can use straight-through cables (see figure below) for all network connections to PCs, servers, and other switches or hubs. With straight-through cable, pins 1, 2, 3, and 6 at one end of the cable are connected straight through to pins 1, 2, 3 and 6 at the other end of the cable. The table below (Table 2.3) shows the 10BASE-T/100BASE-TX/1000BASE-T and MDI/MDI-X port pin outs.

Pin MDI-X	Signal Name	MDI Signal Name
1	Receive Data plus (RD+)	Transmit Data plus (TD+)
2	Receive Data minus (RD-)	Transmit Data minus (TD-)
3	Transmit Data plus (TD+)	Receive Data plus (RD+)
6	Transmit Data minus (TD-)	Receive Data minus (RD-)

Table 2.3
Ethernet Signal Pin Outs

The following figures show the cabling schematics for straight-through and crossover cables.

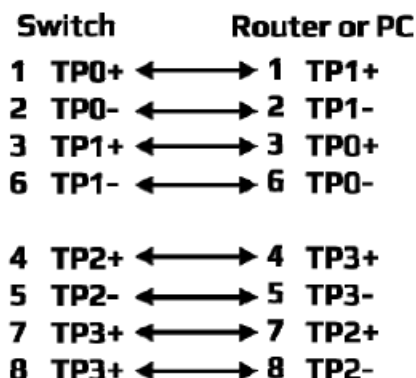

Figure 2.4
 Straight-Through Cables Schematic

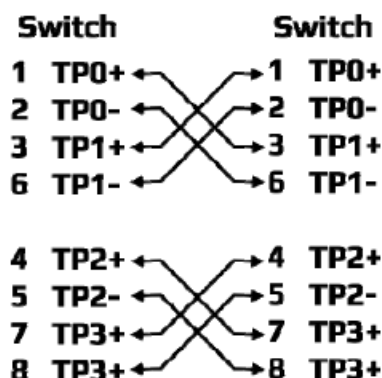

Figure 2.5
 Crossover Cables Schematic

The following figures show the 10,100, and 1000 Ethernet RJ-45 pin outs.

Pin	Label
1	TP0+
2	TP0-
3	TP1+
4	TP2+
5	TP2-
6	TP1-
7	TP3+
8	TP3-

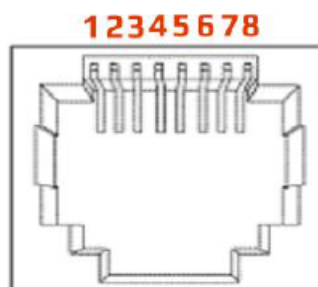

Figure 2.6
 RJ45 Ethernet Port Pin Outs

2.6 Cabling

- Twisted-pair segments can be connected with an unshielded twisted pair (UTP) or shielded twisted pair (STP) cable. The cable must comply with the IEEE 802.3u 100Base TX standard (e.g. Category 5, 5e, or 6, 6e). The cable between the equipment and the link partner (switch, hub, workstation, etc.) must be less than 100 meters (328 ft.) long.
- Note: Cable size should be between 18~20 AWG and the torque should be tightened to 5lbs.

The small form-factor pluggable (SFP) is a compact optical transceiver used in optical communications for both telecommunication and data communication applications.

- To connect the transceiver and LC cable, please follow the steps below:

First, insert the SFP transceiver module into the SFP slot as shown below in *Figure 2.7*. Notice that the triangle mark is at the bottom of the SFP slot. *Figure 2.8* shows SFP transceiver module was inserted.



Figure 2.7 - Transceiver to the SFP Module



Figure 2.8 - Transceiver Inserted

Second, insert the fiber cable of the LC connector into the transceiver as shown below in *Figure 2.9*.

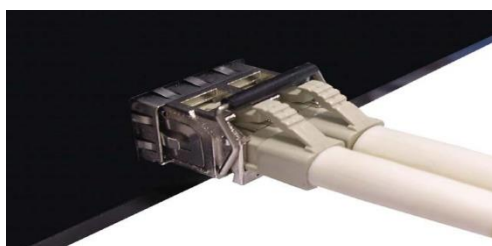

Figure 2.9 - LC Connector to the Transceiver

To remove the LC connector from the transceiver, please follow the steps shown below:

1. Press the upper side of the LC connector from the transceiver and pull it out to release as shown below in *Figure 2.10*.

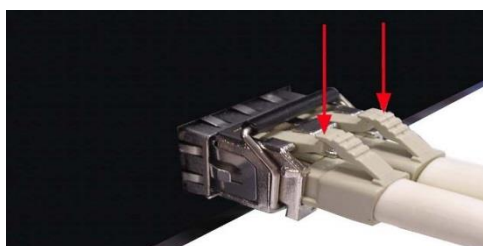

Figure 2.10 - Remove LC Connector

2. Push down the metal clasp and pull the transceiver out by the plastic part as shown below in *Figure 2.11*.

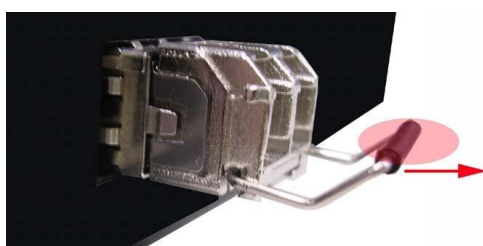

Figure 2.11 - Pull Out from the SFP Module

2.7 Wiring the Power Inputs

Please follow the below steps to insert the power wire.

1. Insert the positive and negative wires into the PWR1 (V1+, V1-) and PWR2 (V2+, V2-) contacts on the terminal block connector as shown below in *Figure 2.12*.



Figure 2.12 - Power Terminal Block

2. Tighten the wire-clamp screws to prevent the wires from loosening, as shown below in *Figure 2.13*.



Figure 2.13 - Power Terminal Block

-
- Note**
- Only use copper conductors, **60/75° C**, tighten to **5 lbs.**
 - The wire gauge for the terminal block should range between **18~20 AWG**.
-

2.8 Wiring the Fault Alarm Contact

The fault alarm contact is in the middle of the terminal block connector as the picture shows below in *Figure 2.14*. By inserting the wires, it will detect the fault status including power failure or port link failure and form a normally open circuit.

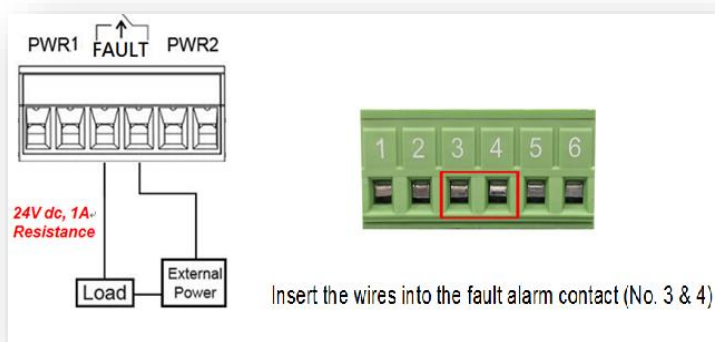

Figure 2.14

Wiring the Fault Alarm Contact

-
- Note**
- The wire gauge for the terminal block should range between **12 ~ 24 AWG**.
 - **If only using one power source, jumper Pin 1 to Pin 5 and Pin 2 to Pin 6 to eliminate power fault alarm.**
-

3. Mounting Installation

3.1 DIN-Rail Mounting

The DIN-Rail is pre-installed on the industrial Ethernet switch from the factory. If the DIN-Rail is not on the industrial Ethernet switch, please refer to *Figure 3.1* to learn how to install the DIN-Rail on the switch.

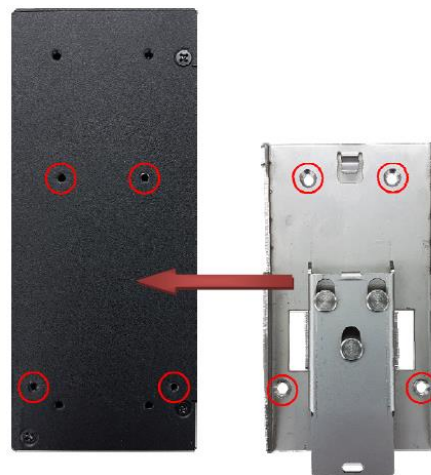

Figure 3.1

The Rear Side of the Switch and DIN-Rail Bracket

Follow the steps below to learn how to hang the industrial Ethernet switch.

1. Use the screws to install the DIN-Rail bracket on the rear side of the industrial Ethernet switch.
2. To remove the DIN-Rail bracket, do the opposite from step 1.
3. After the DIN-Rail bracket is installed on the rear side of the switch, insert the top of the DIN-Rail onto the track as shown below in *Figure 3.2*.
4. Lightly pull down the bracket onto the rail as shown below in *Figure 3.3*.
5. Check if the bracket is mounted tightly on the rail.
6. To remove the industrial Ethernet switch from the rail, do the opposite from the above steps.



Figure 3.2

Insert the Switch on the DIN-Rail

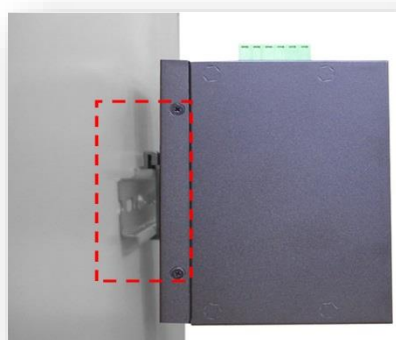

Figure 3.3

Stable the Switch on DIN-Rail

3.2 Wall Mounting

Follow the steps below to mount the industrial Ethernet switch using the wall mounting bracket as shown below in *Figure 3.4*.

1. Remove the DIN-Rail bracket from the industrial Ethernet switch by loosening the screws.
2. Place the wall mounting brackets on the top and bottom of the industrial Ethernet switch.
3. Use the screws to screw the wall mounting bracket on the industrial Ethernet switch.
4. Use the hook holes at the corners of the wall mounting bracket to hang the industrial Ethernet switch on the wall.
5. To remove the wall mount bracket, do the opposite from the steps above.

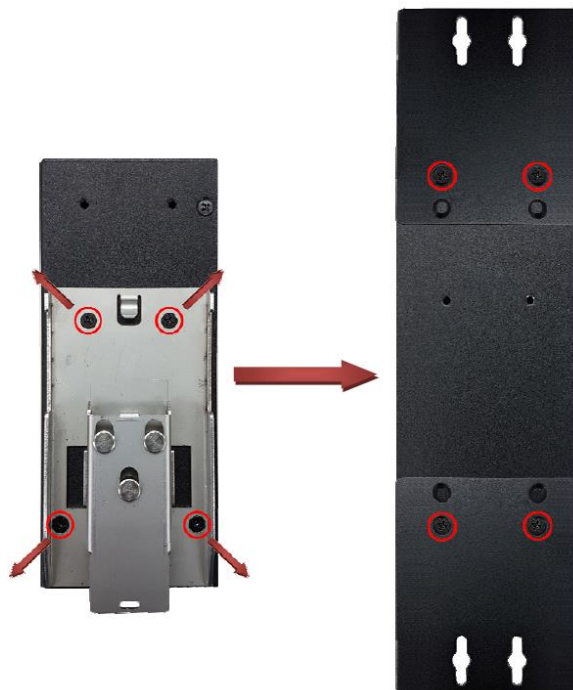

Figure 3.4
Remove DIN-Rail Bracket &
Install Wall Mounting Brackets

Figure 3.5 below has the dimensions for the wall mounting bracket.

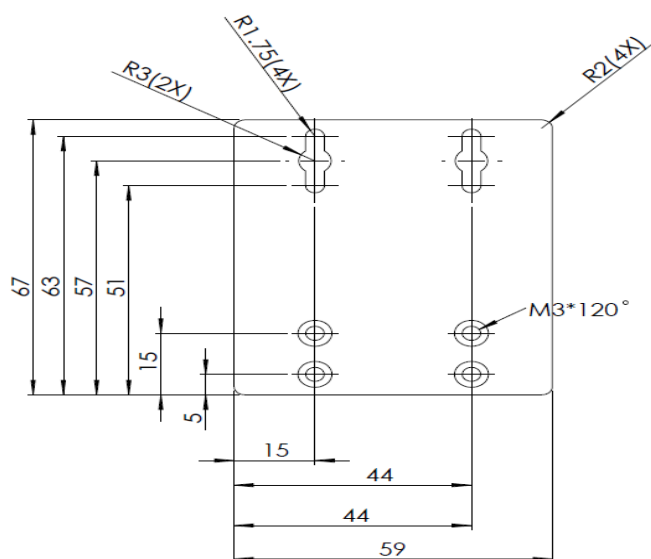

Figure 3.5 – Wall Mounting Bracket Dimensions

4. Hardware Installation

4.1 Installation Steps

This section will explain how to install Antaira Technologies' LNP-1802G-SFP(-T):

Installation Steps

1. Unpack the industrial Ethernet switch from the original packing box.
2. Check if the DIN-Rail bracket is screwed on the industrial Ethernet switch.
 - If the DIN-Rail is not screwed on the industrial Ethernet switch, please refer to the **DIN-Rail Mounting** section for DIN-Rail installation.
 - If it is required to wall mount the industrial Ethernet switch, please refer to the **Wall Mounting** section for wall mounting installation.
3. To hang the industrial Ethernet switch on a DIN-Rail or wall, please refer to the **Mounting Installation** section.
4. Power on the industrial Ethernet switch, then the power LED light will turn on.
 - For help on how to wire power, please refer to the **Wiring the Power Inputs** section.
 - Please refer to the **LED Indicators** section for LED light indication.
5. Prepare the twisted-pair, straight-through category 5 cable for Ethernet connection.
6. Insert one side of the RJ-45 cable into the switch's Ethernet port and on the other side into the networking device's Ethernet port, e.g. switch, PC, or server.
 - The Ethernet port's (RJ-45) LED on the industrial Ethernet switch will turn on when the cable is connected to the networking device.
 - Please refer to the **LED Indicators** section for LED light indication.
7. When all connections are set and the LED lights all show normal, the installation is complete.

5. Network Applications

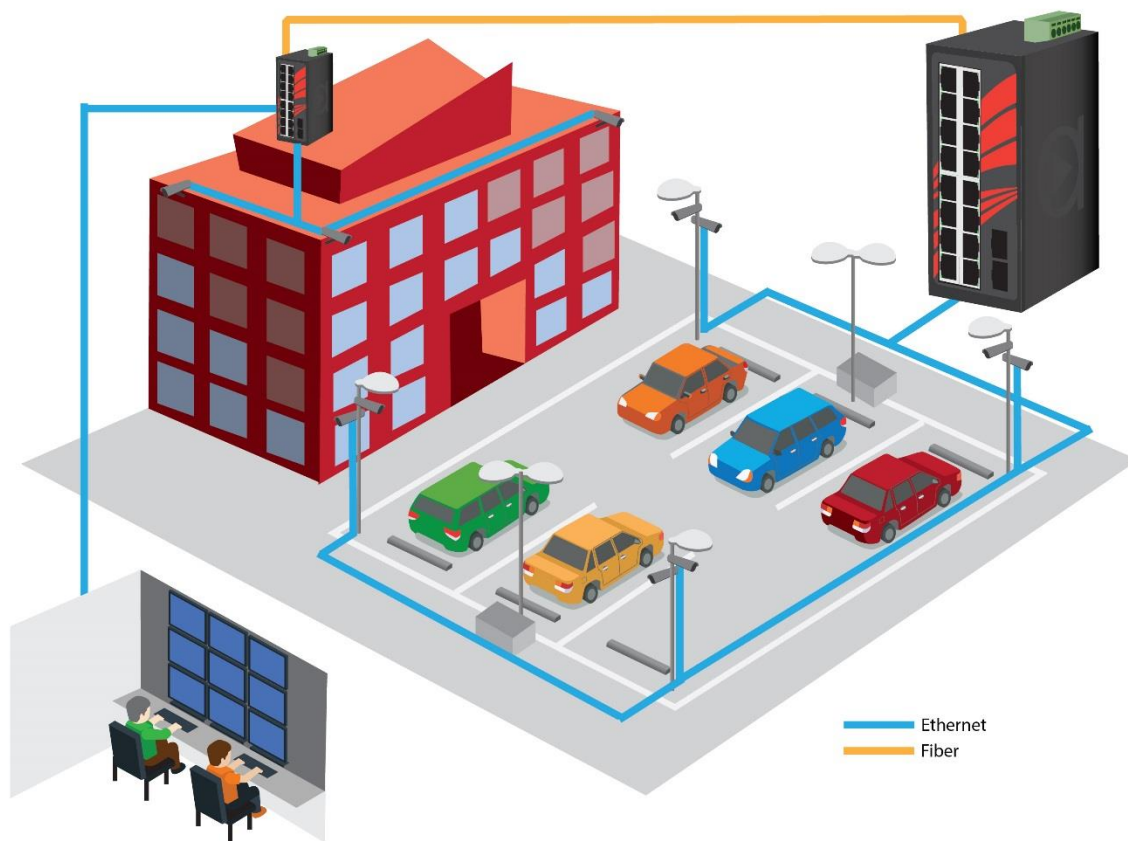

Figure 5.1

Industrial Ethernet Switch Application Reference

6. Troubleshooting

- Always verify the right power cord or adapter is being used. Never use a power supply or adapter with a non-compliant DC output voltage or it will burn the equipment.
- Select the proper UTP or STP cable in order to construct the network. Use an unshielded twisted-pair (UTP) or shield twisted-pair (STP) cable for RJ-45 connections: 100Ω Category 5e for 10/100/1000Mbps. Also be sure that the length of any twisted-pair connection does not exceed 100 meters (328 feet).
- **Diagnosing LED Indicators:** To assist in identifying problems, the switch can be easily monitored with the LED indicators which help to identify if any problems exist.
 - Please refer to the **LED Indicators** section for LED light indication.
- If the power indicator LED does not turn on when the power cord is plugged in, the user may have a problem with the power cord. Check for loose power connections, power losses, or surges at the power outlet.
 - Please contact Antaira for technical support service, if the problem still cannot be resolved.
- If the industrial switch LED indicators are normal and the connected cables are correct but the packets still cannot transmit, please check the system's Ethernet devices' configuration or status.

7. Technical Specifications

Table 7.1 has the technical specifications for Antaira Technologies' LNP-1802G-SFP series:

Standards	IEEE 802.3	10Base-T 10Mbit/s Ethernet
	IEEE 802.3u	100Base-Tx, 100Base-Fx, Fast Ethernet
	IEEE 802.3ab	1000Base-Tx Gigabit Ethernet
	IEEE 802.3z	1000Base-X Gigabit Fiber
	IEEE 802.3af/at	Power over Ethernet
Switch Property	Protocol	CSMA/CD
	Data Process	Store and Forward
	Flow Control	IEEE 802.3x flow control, back pressure flow control
	Switch Architecture	Back-Plane: Non-Blocking Switching Fabric
	Transfer Rate	14,880pps for 10Base-T Ethernet port 148,800pps for 100Base-TX Fast Ethernet port 1,488,000pps for Gigabit Ethernet port
	Transmission Distance	Up to 100M (Fast Ethernet)
	Transmission Speed	Up to 1000Mbps (Gigabit)
	Memory Buffer	512Kbytes
	Jumbo Frame	9,216Kbytes
	MAC Table Size	8K MAC Address
Port Interface	Ethernet (RJ45) Port	16*10/100/1000Tx, auto negotiation speed, full/half duplex mode, and auto MDI/MDI-X connection
	Fiber Port	2*100/1000 SFP Slots
	Fiber Wavelength	Depends on SFP Modules
	LED Indicator	Power 1, Power 2, Fault Ethernet Ports: On-Link/Flash-data transmitting PoE: On- Link / Flashing- Data transmitting SFP: Link/Active
	Network Cable	10Tx: 2-pair UTP/STP Cat.3,4,5 cable EIA/TIA-568 100-ohm (100m) 100Tx: 2-pair UTP/STP Cat.5 cable EIA/TIA-568 100-ohm (100m) 1000Tx: UTP/STP Cat.5/5E cable EIA/TIA-568 100-ohm (100m)
Mechanical Characteristics	Housing	Metal IP30 protection
	Dimension	67 x 142 x 99 mm (W x H x D)
	Weight	Unit Weight: 2.65 lbs. Shipping Weight: 3.09 lbs.
	Mounting	DIN-Rail Mounting, wall-mounting (optional)
Power Requirement	Input Voltage	48~55VDC Redundant Input
	Power Connection	1 removable 6-contact terminal block
	Overload Current Protection	Present
	Reverse Polarity Protection	Present
	Power Consumption	15 Watts for System
	Relay Contact	24 VDC, 1A resistive
Environmental Limits	Operating Temperature	Standard: -10° to 65°C (14° to 149°F); EOT: -40° to 75°C (-40° to 167°F)
	Operating Humidity	5% to 95% (Non-Condensing)

	Storage Temperature	-40° to 85°C (-40° ~ 185°F)
Regulatory Approvals	EMI	FCC Part 15 Subpart B Class A, CE EN 55022 Class A
	EMS	IEC61000-4-2 (ESD), IEC61000-4-3 (RS), IEC61000-4-4 (EFT), IEC61000-4-5 (Surge), IEC61000-4-6 (CS), IEC-61000-4-8 (Magnetic Field)
	Stability Testing	IEC60068-2-32 (Free fall) IEC60068-2-27 (Shock) IEC60068-2-6 (Vibration)
	Green	RoHS Compliant
	Compliance	UL 61010-1 (Pending), UL 61010-2-201 (Pending)
	Safety Certificate	FCC, CE
	Warranty	5 Years

Table 7.1

Antaira Customer Service and Support

(Antaira US Headquarter) + 844-268-2472

(Antaira Europe Office) + 48-22-862-88-81

(Antaira Asia Office) + 886-2-2218-9733

Please report any problems to Antaira:

www.antaira.com / support@antaira.com

www.antaira.eu / info@antaira.eu

www.antaira.com.tw / info@antaira.com.tw

Any changes to this material will be announced on the Antaira website.